MULTI SPLIT SYSTEM AIR CONDITIONERS

Come home to comfort with LG



The Total HVAC and Energy Solution Provider

Ever since manufacturing Korea's first homegrown air conditioner in 1968, LG has remained at the forefront of air conditioning innovation. And in 2008, LG became the first company to sell a cumulative total of more than 100 million air conditioners.

Building on its success and technological leadership in the residential air conditioning sector, LG has moved into system air conditioning as well. The company's range of

high-performance system air conditioning products provides effective temperature control to large-scale buildings and facilities. Over time, LG has evolved into the total HVAC and energy solution provider, investing in new technologies and adding chillers, VRF systems, and building management systems (BMS) into its comprehensive product portfolio.

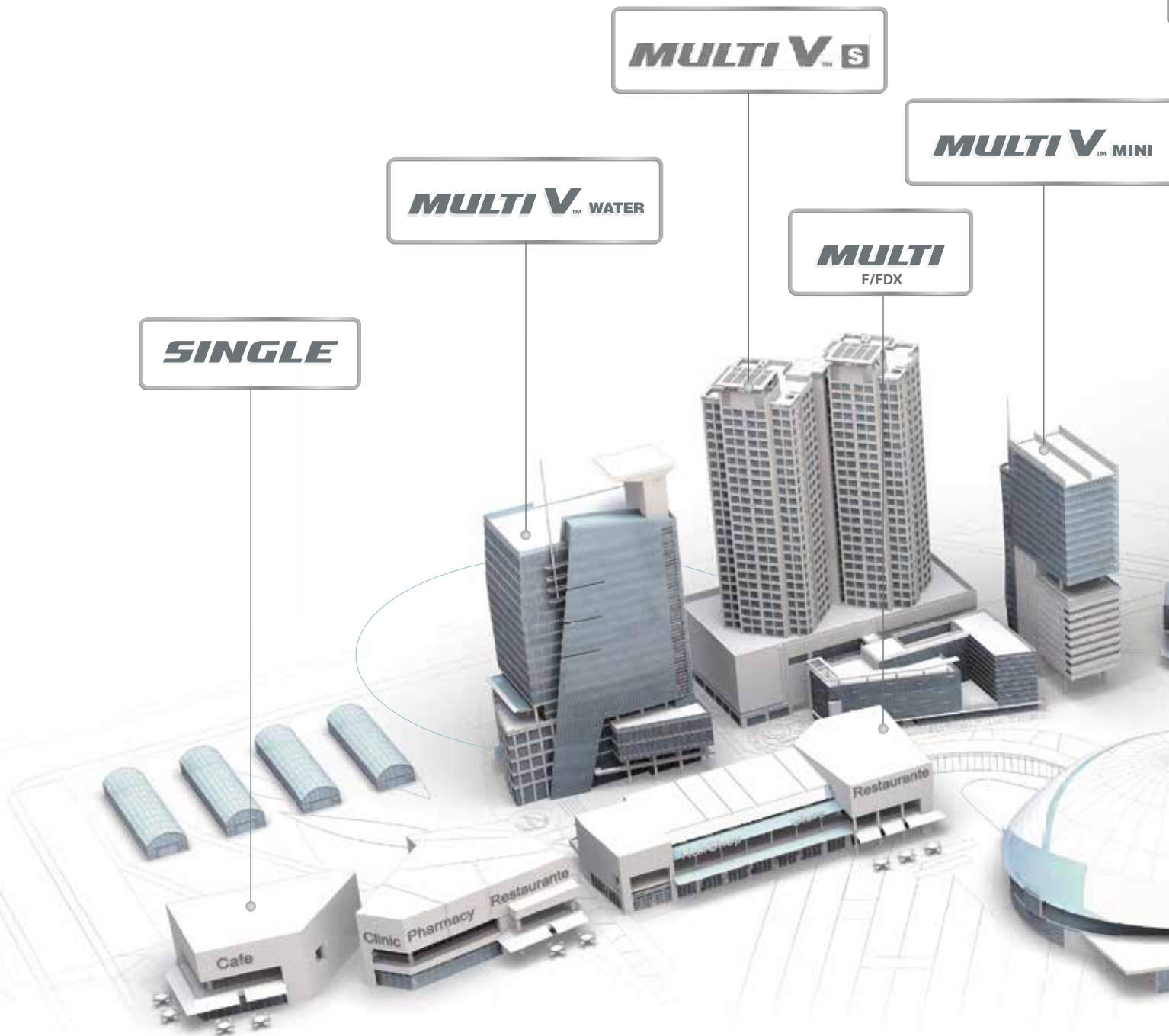

LG operates several state-of-the-art R&D facilities in various countries. One such facility is the Energy Lab, a purpose-built R&D and testing center in northern France. Helping to keep the company at the forefront of innovation, the scientists and engineers at the Energy Lab study the effects of different environmental conditions on LG's products. This in-depth research and analysis enables LG to tailor its solutions to the various environmental demands of individual markets.

With 10 manufacturing plants throughout the world, LG produces in excess of 17 million reliable compressors and 16 million first-class HVAC solutions per year. Combining the great technologies with the great ideas, LG's high quality products are now enjoyed by consumers in over 100 countries.

MULTI V™

CHILLER

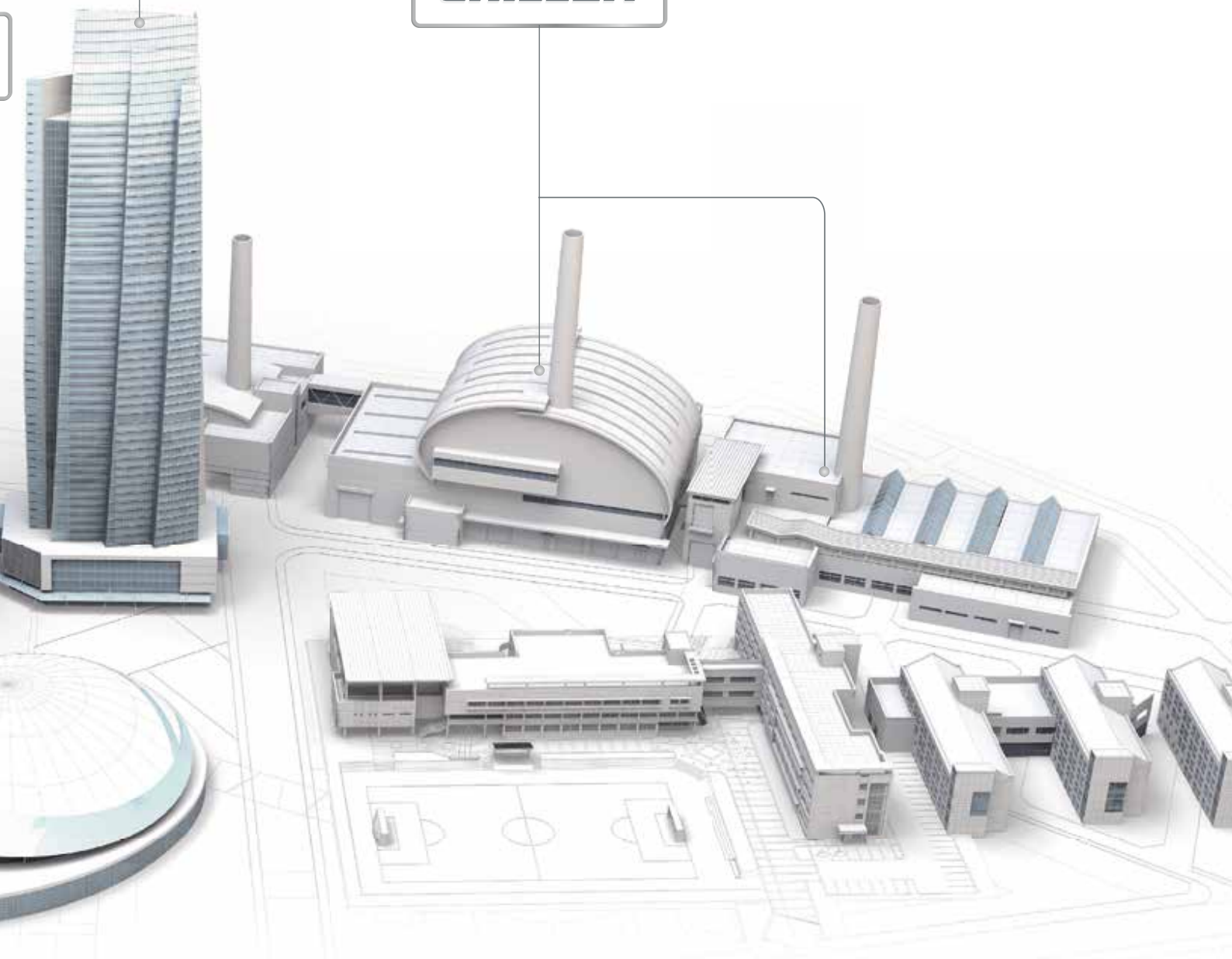

Come Home To Comfort with LG air conditioners

LG makes life good by connecting with the real needs and desires of our customers and innovating around them. We passionately believe in improving the day-to-day lives of Australians via forward-thinking technological advancement.

Why LG Air Conditioning

Designed for the way you live, our air conditioners are available in a wide range of styles - so you can create a space that's cool, comfortable and stylish.

LG Multi-Split Systems Perfect Solution for Multiple Rooms

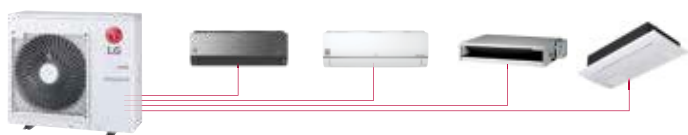

Energy Efficiency | Extreme Durability | Comfort and Convenience

LG Multi split system provides powerful, efficient cooling and heating with two, three, four, or up to nine indoor units operating off a single outdoor unit.

LG's advanced inverter technology brings powerful performance while consuming less energy and it uses less space than installing individual single split systems.

A variety of sleek and elegant indoor units to complement any décor are available in a full range of capacities for all room sizes.





Installation is easy and it offers various convenient functions for easy maintenance.





MODEL LINE-UP

OUTDOOR UNITS

Type kW	MULTI F (Multi Piping)	Max. Indoor units	Phase	Max IDU	Combination Sample
5.3	 UHXM55MA1	3	1ø	8.79	
7.0	 UHXM70MA1	4	1ø	11.42	
8.8	 UHXM90MA1	5	1ø	15.81	
11.2	 UHXM110MA1	5	1ø	21.08	

INDOOR UNITS

kW	Type	Wall Mounted		Ceiling Cassettes	Celing Concealed Ducts
		Standard	ART COOL Mirror		Low Static
2.1		 MS07AH2	 NHXM20S2A2		
2.6		 MS09AH2	 NHXM30S2A2	 NHXM30C1A1	 NHXM30D3A1
3.5		 MS12AH2	 NHXM40S2A2	 NHXM40C1A1	 NHXM40D3A1
5.3		 MS18AH2	 NHXM50S2A2		 NHXM50D3A1
7.0		 MS24AH2	 NHXM70S2A2		 NHXM70D3A1

FUNCTION SPECIFICATIONS

Category		Multi F			
kBtu/h		18	24	30	38
kW		5.27	7.03	8.79	11.2
Energy Efficiency	BLDC Comp & Fan Motor	•	•	•	•
	Wide Louver Plus Fin	•	•	•	•
	Optimised Heat Exchanger Path	•	•	•	•
	Smart Load Control	•	•	•	•
	Peak Current Control	•	•	•	•
	Standby Mode	•	•	•	•
	Mode Lock	•	•	•	•
Durability	Twin Rotary Compressor	•	•	•	•
	Smart Sensor Pressure Control	•	•	•	•
Comfort & Convenience	Fast Cooling & Heating	•	•	•	•
	Silent Night Operation	•	•	•	•
	Wiring Error Check	•	•	•	•
	Monitoring PCB	•	•	•	•
	LG MV	•	•	•	•
	Forced Cooling Operation	•	•	•	•

KEY FEATURES

ENERGY EFFICIENCY TECHNOLOGIES

Built-in Wi-Fi Smart Control

Come home to comfort

The LG Smart ThinQ App lets you access and control your air conditioner with your smartphone* even when you're not at home.



I Controlling & Monitoring I

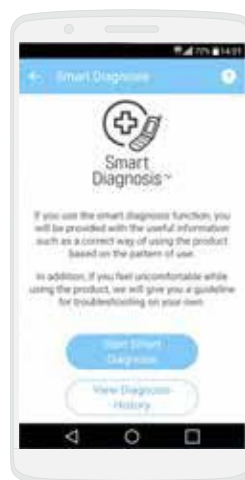

I Smart Diagnosis & Filter Manager I

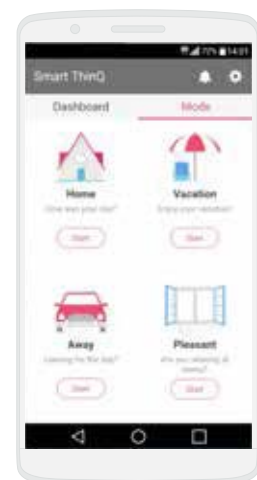

I Integrated Home Appliances Control I

*Feature can be accessed using LG Smart ThinQ app on Android or IOS smartphones. Internet connection required. Wi-Fi dongle required for Cassettes & Ducted heads.



ENERGY EFFICIENCY TECHNOLOGIES

Energy Efficiency

The advanced technologies of LG achieve low energy consumption regarding SEER.



Powerful BLDC (Brushless Direct Current Motor) Compressor

LG air conditioners are equipped with a BLDC Inverter Twin Rotary Compressor that uses a neodymium magnetic core. The compressor has high efficiency and reliability, because it is excellent in controlling the operating speed depending on the load. The compressor has improved efficiency compared to standard AC inverter products and optimised for changes of outdoor load, and seasonal efficiency.

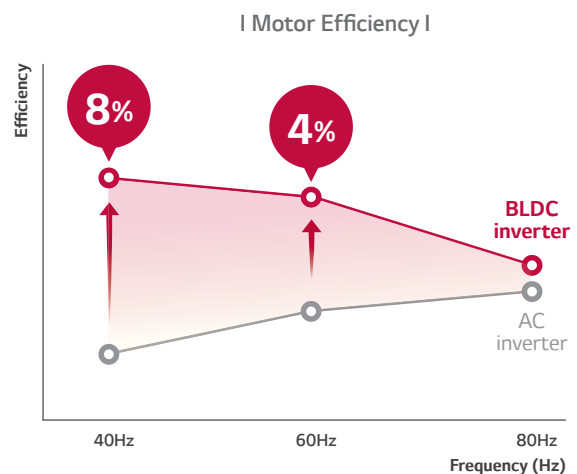
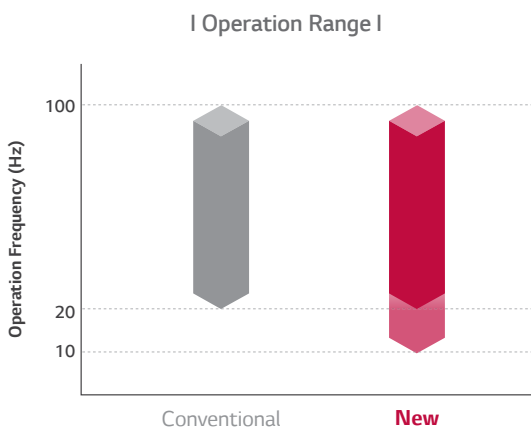

Wide Louver Plus Fin

Wide Louver Plus fin technology increases full load heating performance by 11% and 6% with COP compared to conventional fins. It can also slow down the frosting on the heat exchanger and delay the start of defrosting mode.

Previous LG model

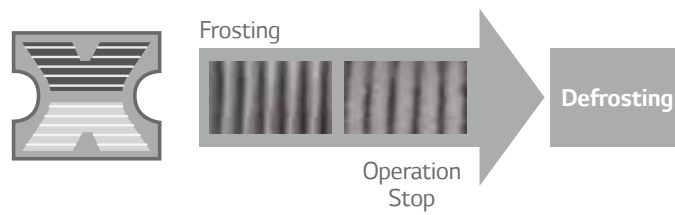

Wide Louver Plus

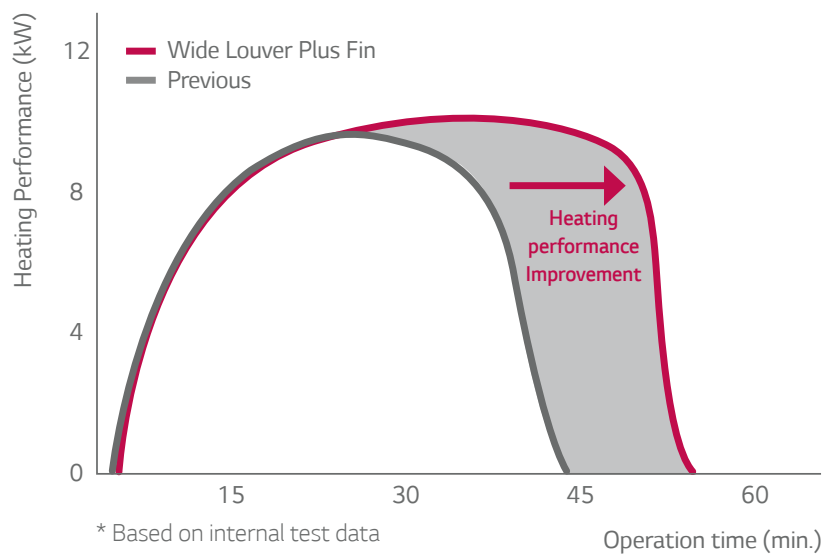
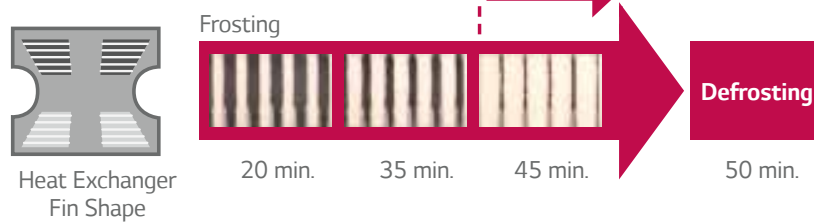

KEY FEATURES

ENERGY EFFICIENCY TECHNOLOGIES

Smart Load Control

To save operation energy, it automatically controls the refrigerant temperature according to outside temperature.

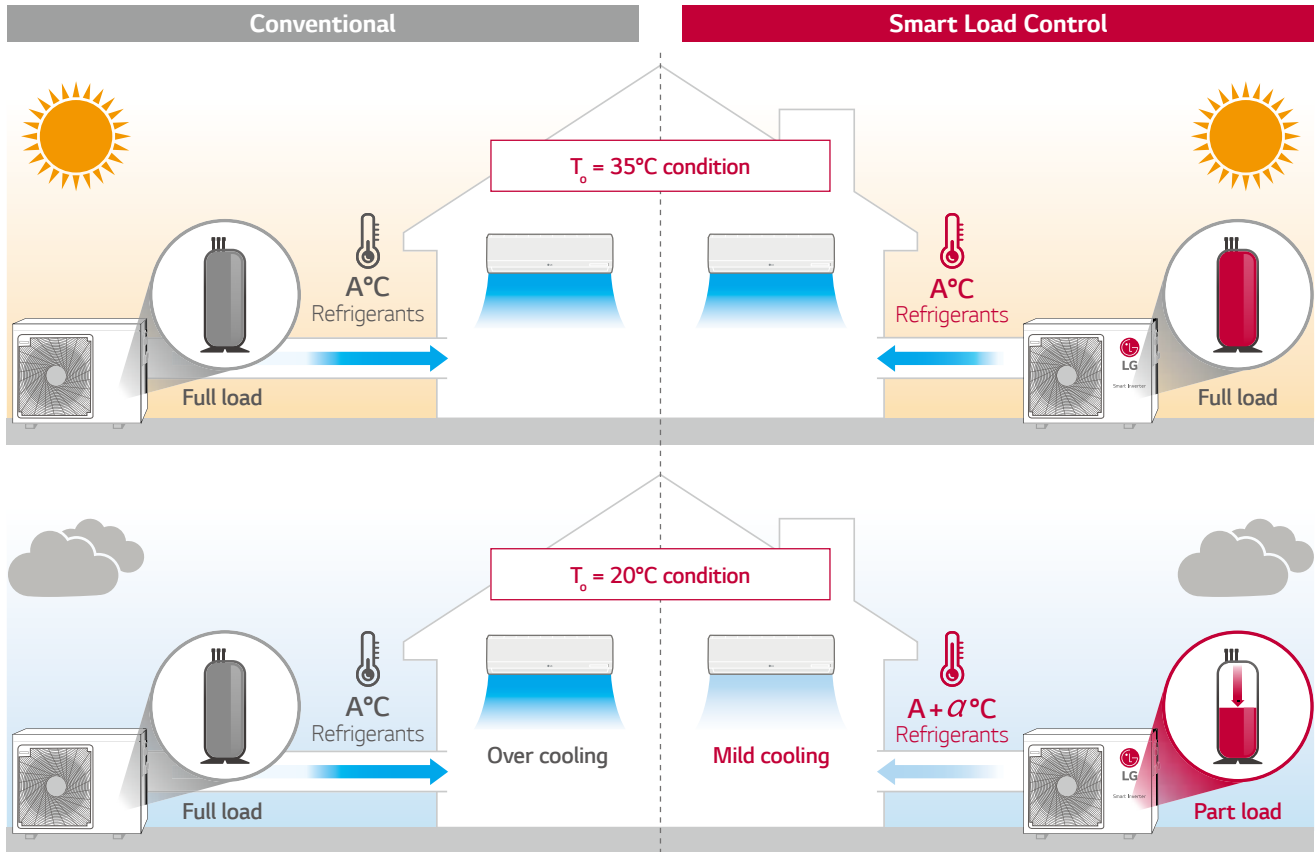

* T_o : Outdoor temperature
 * A is the indoor unit coil temperature

I How to set Dip Switch I

To operate smart load control, dip switch setting is required. It can help save energy during real time operation.

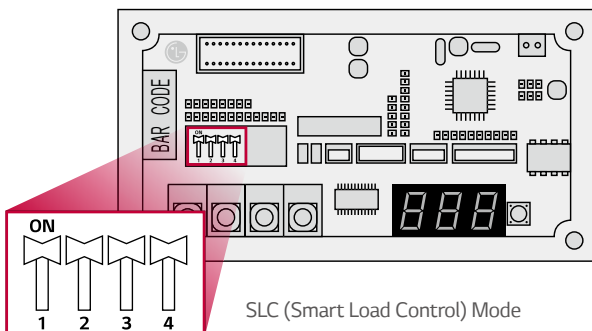

I Real Time Energy Saving I

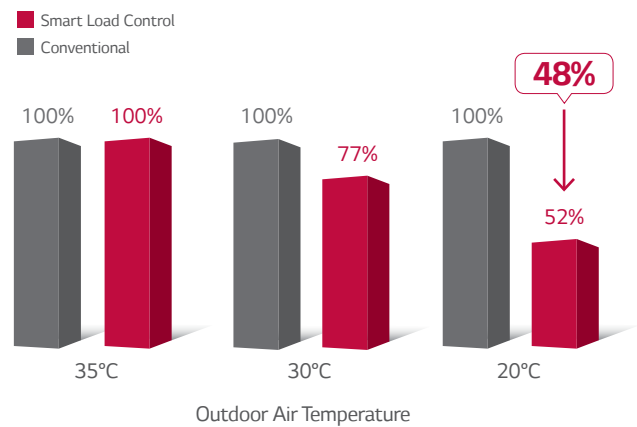

*Tested model 6.2kW.

KEY FEATURES

QUICK COOLING & HEATING

Quick Operating Response

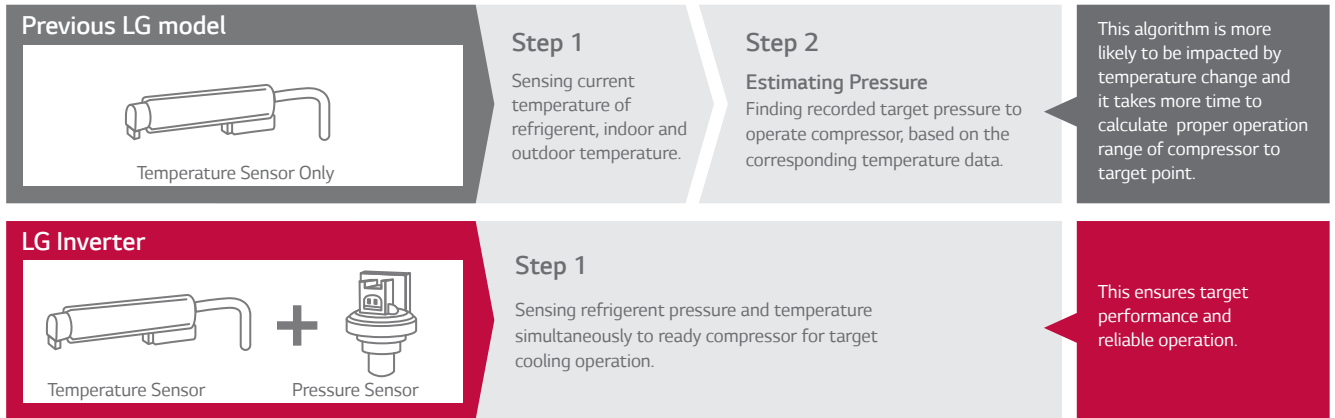

Using both pressure and temperature sensors improves control accuracy and stability resulting in a quick operating response time.

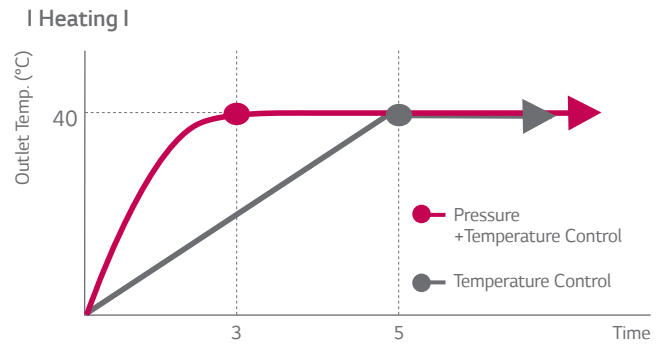

* Based on internal test data

Smart Inverter Compressor™

The LG Smart Inverter Compressor™ is designed to cope with high temperatures, so great for those hot Australian conditions. With the 10 year compressor parts warranty, you have the peace of mind that you can come home to comfort for years to come.



KEY FEATURES

SAVE COST & ENERGY

Peak Current Control (optional setting)

The peak current control function limits the air conditioner from running at the maximum level thus improving operating efficiency to help reduce energy consumption.

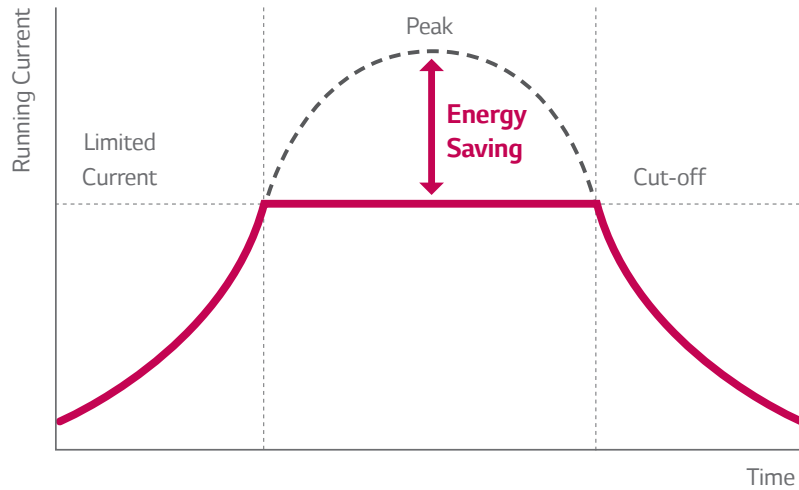

*This function is not user adjustable, please contact your nearest AC installer.

Mode Lock

Set the operation mode to either cooling-only or heating-only by adjusting the dip switch inside the unit. This will help prevent the mixed use of cooling and heating.

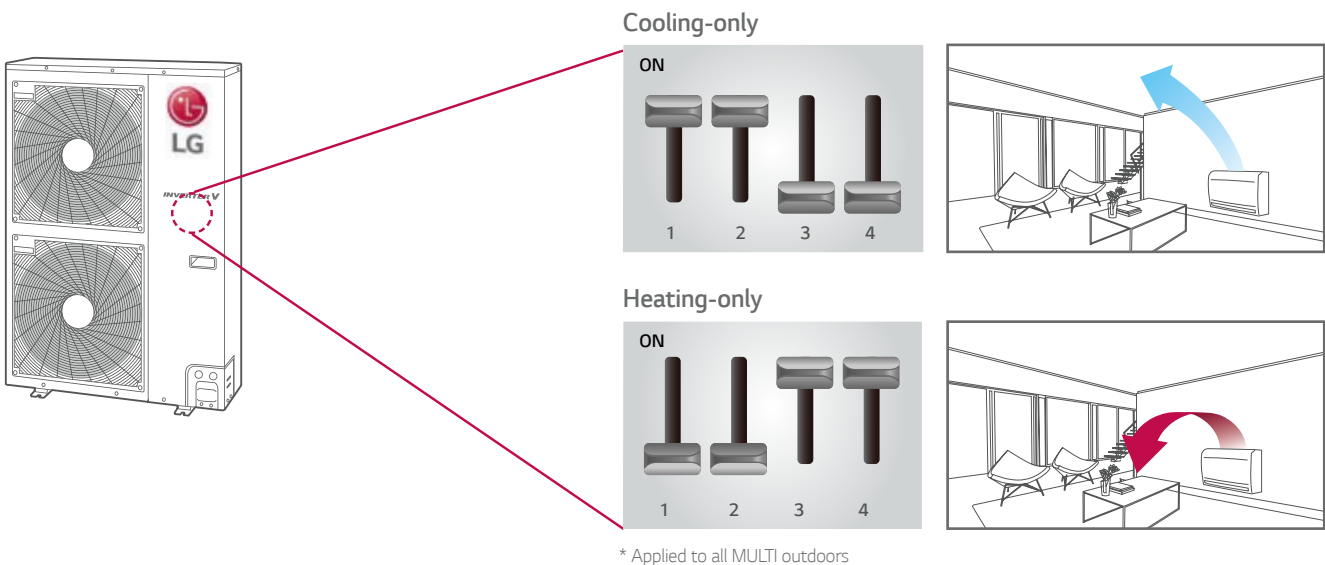

*This function is not user adjustable, please contact your nearest AC installer.

KEY FEATURES

QUIET OPERATION

"Night Quiet" Operation

Night Quiet operation can reduce noise levels at night time by setting the dip switch on the PCB in the outdoor unit*.

I Cooling Mode I

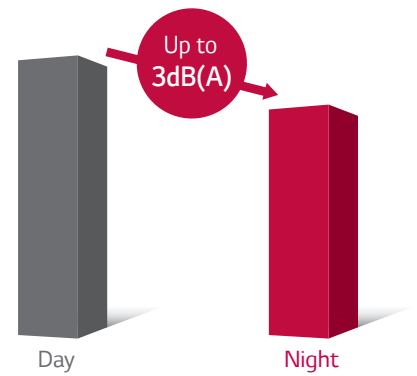
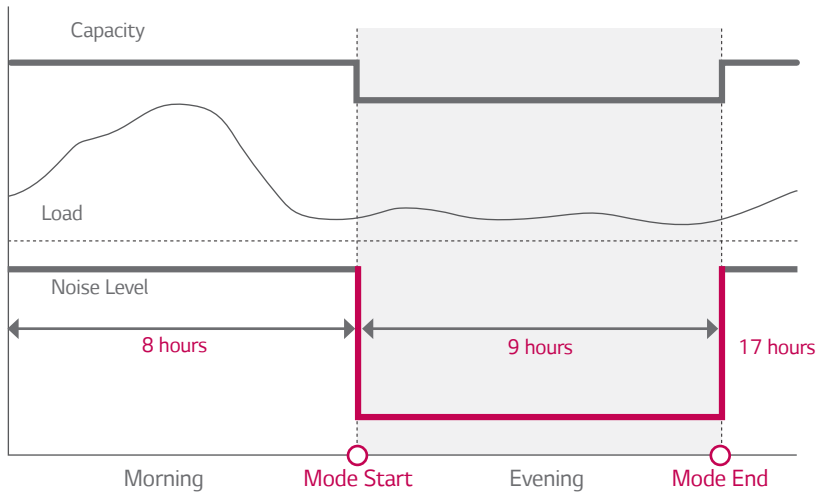

*This function is not user adjustable, please contact your nearest AC installer.



KEY FEATURES

EASY INSTALLATION & MAINTENANCE

Wiring Error Check (UHXM55MA1, UHXM70MA1, UHXM90MA1, UHXM110MA1)

Installers can check whether the transmission cable has been connected correctly by using the wiring error check function. The wiring error check can reduce the time taken to check for transmission cable errors.

I Check with Outdoor PCB : When error → LED is turned on I

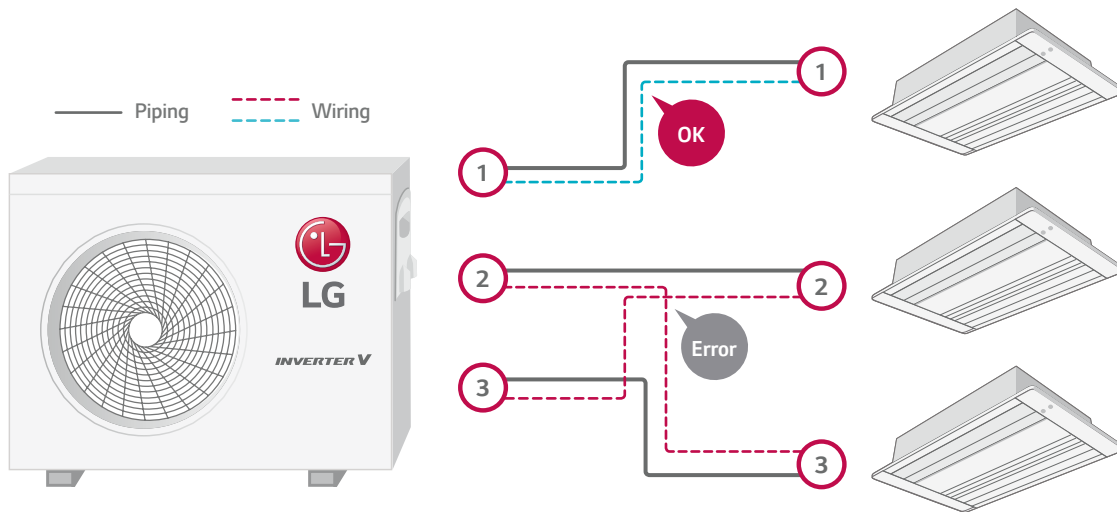

KEY FEATURES

EASY INSTALLATION & MAINTENANCE

LG MV (Monitoring View)

LG MV helps technicians inspect and monitor air conditioning units easily. Information is provided by product type. (Single Split & Multi Split)



- IDU info.
- Cycle & valves
- Actuator info.
- Sensors & Electric
- ODU info.

LG MV provides cycle information with diagrams and the technicians can check accumulated data on a graph.

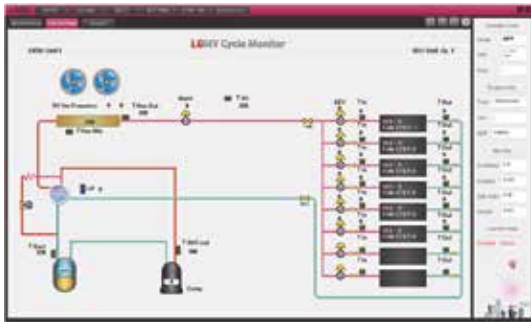

A manager can easily check the error status by looking at the indicator information (Troubleshooting guide)

Error indicator

Error Code	Contents
01	Air temperature sensor of indoor unit
02	Inlet pipe temperature sensor of indoor unit
03	Communication error : wired remote controller ↔ indoor unit

•
•
•

Pump Down Mode

The forced cooling operation allows refrigerant to be recharged or pumped down, regardless of the indoor temperature. More importantly this function can be used when indoor units are being repaired.

I Recharging I

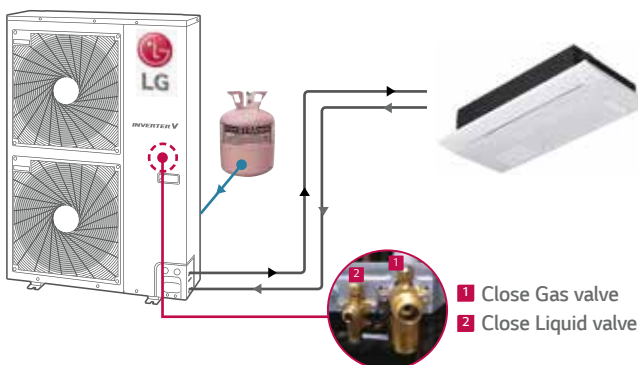

I Pump Down I

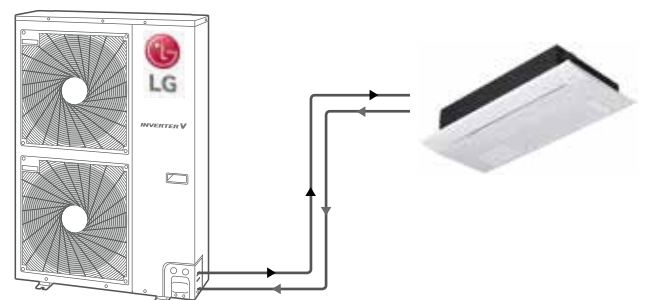

KEY FEATURES

FLEXIBLE COMBINATION

Long and High Elevation Piping

I Multiple Piping Type I

(m)		UHXM55MA1	UHXM70MA1	UHXM90MA1	UHXM110MA1
Total Piping Length		50	70	75	85
Piping Length per Branch		25	25	25	25
Max. Elevation	Indoor-Outdoor	15	15	15	15
	Indoor-Indoor	7.5	7.5	7.5	7.5

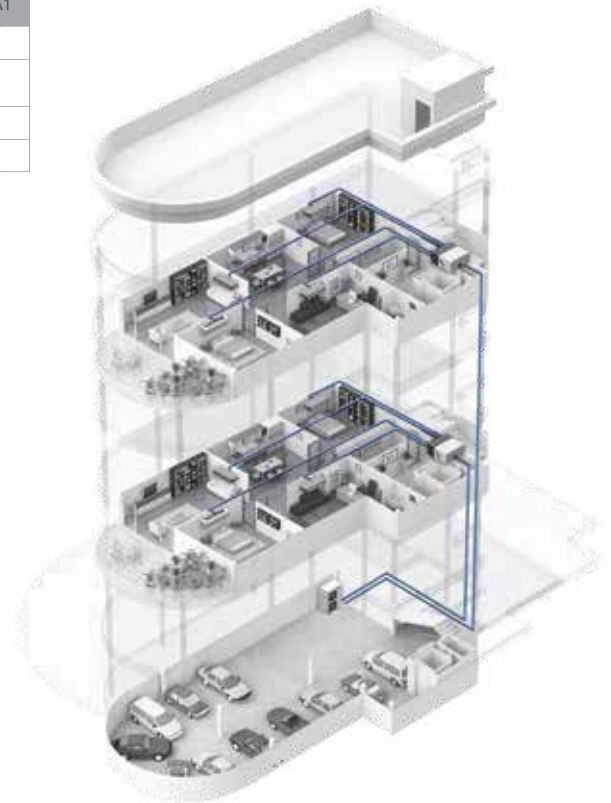
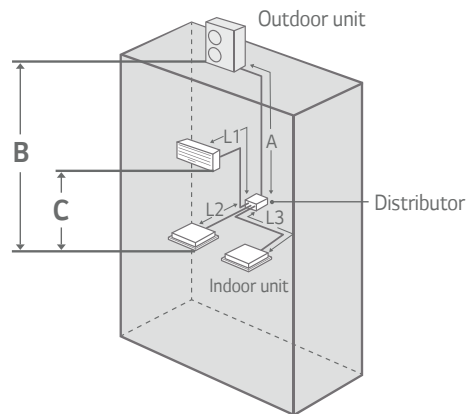

Indoor Capacity Combination

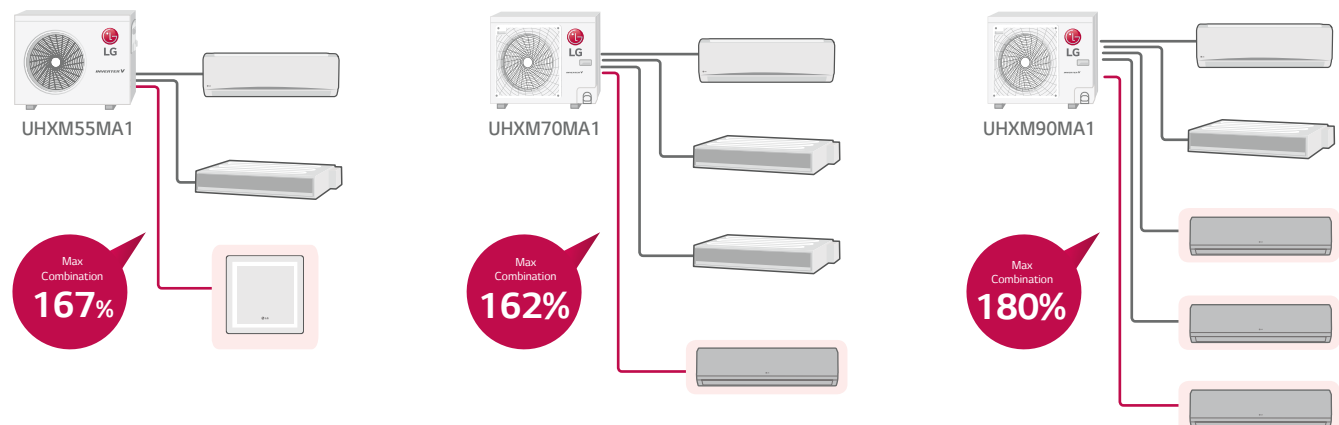

• UHXM110MA1 : 180%

OUTDOOR UNITS



OUTDOOR UNITS

SPECIFICATIONS

UHXM55MA1

MULTI F

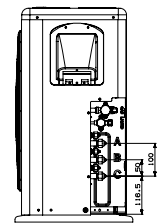
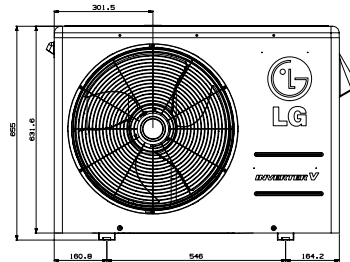
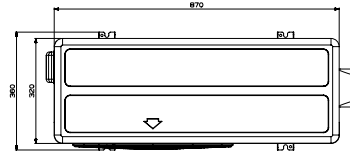

(Unit : mm)

Outdoor Unit				UHXM55MA1
Compressor	Type			Twin Rotary
Capacity *	Cooling	Min/Norm/Max	kW	1.35/5.27/6.33
	Heating	Min/Norm/Max	kW	1.41/6.33/7.27
Power Input *	Cooling	Min/Norm/Max	kW	0.14/1.29/2.08
	Heating	Min/Norm/Max	kW	0.18/1.53/2.64
Running Current	Cooling	Min/Norm/Max	A	0.6/6.0/9.0
	Heating	Min/Norm/Max	A	0.8/7.0/11.5
EER				4.57
COP				4.15
Airflow Rate	Norm		m ³ /min	31
			I/S	517
Sound Pressure	Cooling	Norm	dBA	50
	Heating	Norm	dBA	52
Dimensions	WxHxD		mm	870×655×320
Net Weight				45.0
Refrigerant	Type			R410A
	Charge		g	1,700
	Additional Charge		g/m	20
Operation Range (Outdoor)	Cooling	Min-Max	°C DB	-10-48
	Heating	Min-Max	°C WB	-18-18
Power Supply			ø/V/Hz	1/220-240/50
Power Supply Cable			No.xmm ²	3C×2.5
Transmission Cable			No.xmm ²	4C×0.75
Circuit Breaker			A	20
Piping Length Total			m	50
Piping Length per Branch		Max	m	25
Piping Elevation Difference	IDU-ODU	Max	m	15
	IDU-IDU	Max	m	7.5
Piping Connection	Liquid	mm(inch)×No.		ø 6.35 (1/4)×3
	Gas	mm(inch)×No.		ø 9.52 (3/8)×3

Notes :

1 Capacities are based on the following conditions:

Cooling : - Indoor Temperature 27°C (80.6°F) DB / 19°C (66.2°F) WB
 - Outdoor Temperature 35°C (95°F) DB / 24°C (75.2°F) WB
 Heating : - Indoor Temperature 20°C (68°F) DB / 15°C (59°F) WB
 - Outdoor Temperature 7°C (44.6°F) DB / 6°C (42.8°F) WB

Piping Length - Interconnecting Piping Length 7.5m
 - Level Difference of Zero.

2 * : See page "Combination Table".

3 Due to our policy of innovation some specifications may be changed without notification.

4 At least two indoor units should be connected.

5 Minimum combination capacity rate should be more than 40%.

OUTDOOR UNITS

SPECIFICATIONS

UHXM70MA1 / UHXM90MA1

MULTI F

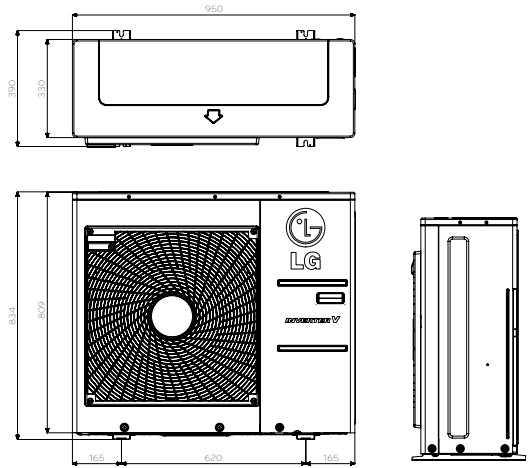

(Unit : mm)

Outdoor Unit				UHXM70MA1	UHXM90MA1
Compressor	Type			Twin Rotary	Twin Rotary
Capacity *	Cooling	Min/Norm/Max	kW	1.32/7.03/8.5	1.32/8.79/10.6
	Heating	Min/Norm/Max	kW	1.45/8.44/9.38	1.47/10.1/12.1
Power Input *	Cooling	Min/Norm/Max	kW	0.44/1.67/2.59	0.44/2.20/3.3
	Heating	Min/Norm/Max	kW	0.5/1.80/2.99	0.5/2.20/3.7
Running Current	Cooling	Min/Norm/Max	A	2.0/7.2/11.1	2.0/9.9/16.2
	Heating	Min/Norm/Max	A	2.2/8.1/12.8	2.2/9.8/16.5
EER				4.59	4.26
COP				4.59	4.58
Airflow Rate		Norm	m ³ /min	30	30
			I/S	500	500
Sound Pressure	Cooling	Norm	dB(A)	51	51
	Heating	Norm	dB(A)	53	53
Dimensions	WxHxD		mm	950x834x330	950x834x330
Net Weight			kg	64.0	64.0
Refrigerant	Type			R410A	R410A
	Charge		g	3,200	3,200
	Additional Charge		g/m	20	20
Operation Range (Outdoor)	Cooling	Min-Max	°C DB	-10-48	-10-48
	Heating	Min-Max	°C WB	-18-18	-18-18
Power Supply			∅/V/Hz	1/220-240/50	1/220-240/50
Power Supply Cable			No.xmm ²	3C×2.5	3C×2.5
Transmission Cable			No.xmm ²	4C×0.75	4C×0.75
Circuit Breaker			A	25	25
Piping Length Total			m	70	75
Piping Length per Branch		Max	m	25	25
Piping Elevation Difference	IDU-ODU	Max	m	15	15
	IDU-IDU	Max	m	7.5	7.5
Piping Connection	Liquid		mm(inch)×No.	∅ 6.35 (1/4)×4	∅ 6.35 (1/4)×5
	Gas		mm(inch)×No.	∅ 9.52 (3/8)×4	∅ 9.52 (3/8)×5

Notes :

1 Capacities are based on the following conditions:

- Cooling : - Indoor Temperature 27°C (80.6°F) DB / 19°C (66.2°F) WB
- Outdoor Temperature 35°C (95°F) DB / 24°C (75.2°F) WB
- Heating : - Indoor Temperature 20°C (68°F) DB / 15°C (59°F) WB
- Outdoor Temperature 7°C (44.6°F) DB / 6°C (42.8°F) WB

Piping Length - Interconnecting Piping Length 7.5m
- Level Difference of Zero.

2 * - See page "Combination Table".

- 3 Due to our policy of innovation some specifications may be changed without notification.
- 4 At least two indoor units should be connected.
- 5 Minimum combination capacity rate should be more than 40%.

UHXM110MA1

MULTI F

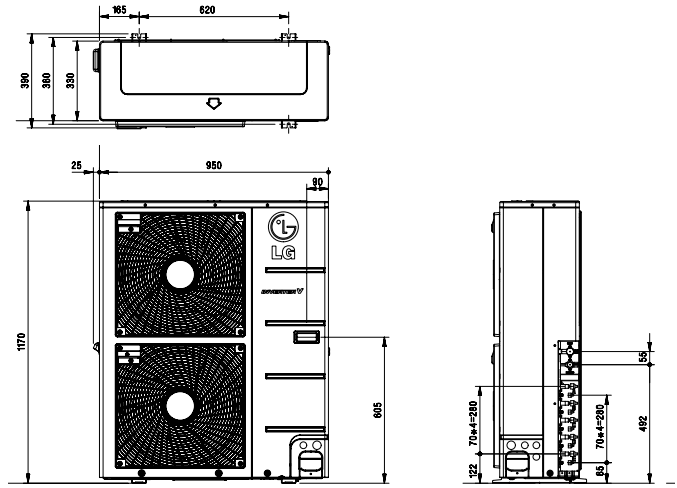

(Unit : mm)

Outdoor Unit				UHXM110MA1
Compressor	Type			Twin Rotary
Capacity *	Cooling	Min/Norm/Max	kW	0.88/11.2/13.55
	Heating	Min/Norm/Max	kW	0.97/12.5/15.0
Power Input *	Cooling	Min/Norm/Max	kW	0.78/2.73/4.15
	Heating	Min/Norm/Max	kW	0.82/2.81/4.45
Running Current	Cooling	Min/Norm/Max	A	3.5/12.1/18.4
	Heating	Min/Norm/Max	A	3.6/12.5/19.7
EER				4.38
COP				4.42
Airflow Rate	Norm		m ³ /min	34
			I/S	1,146
Sound Pressure	Cooling	Norm	dBA	53
	Heating	Norm	dBA	55
Dimensions	WxHxD		mm	950×1,170×330
Net Weight			kg	84.0
Refrigerant	Type			R410A
	Charge	g		3,800
	Additional Charge	g/m		20
Operation Range (Outdoor)	Cooling	Min-Max	°C DB	-10~48
	Heating	Min-Max	°C WB	-18~18
Power Supply			ø/V/Hz	1/220-240/50
Power Supply Cable			No.xmm ²	3C×3.5
Transmission Cable			No.xmm ²	4C×0.75
Circuit Breaker			A	30
Piping Length Total			m	85
Piping Length per Branch	Max		m	25
Piping Elevation Difference	IDU-ODU	Max	m	15
	IDU-IDU	Max	m	7.5
Piping Connection	Liquid	mm(inch)×No.		ø 6.35 (1/4)×5
	Gas	mm(inch)×No.		ø 9.52 (3/8)×5

Notes :

- 1 Capacities are based on the following conditions:
 Cooling : - Indoor Temperature 27°C (80.6°F) DB / 19°C (66.2°F) WB
 - Outdoor Temperature 35°C (95°F) DB / 24°C (75.2°F) WB
 Heating : - Indoor Temperature 20°C (68°F) DB / 15°C (59°F) WB
 - Outdoor Temperature 7°C (44.6°F) DB / 6°C (42.8°F) WB
 Piping Length - Interconnecting Piping Length 7.5m
 - Level Difference of Zero.

- 2 * : See page "Combination Table".
 3 Due to our policy of innovation some specifications may be changed without notification.
 4 At least two indoor units should be connected.
 5 Minimum combination capacity rate should be more than 40%.

INDOOR UNITS



KEY FEATURES

WALL MOUNTED

Plasmaster Ioniser Plus

Breathe easier with improved air quality

The LG ArtCool Mirror range comes with the Plasmaster Ioniser, which generates over 3 million plasma ions which filtrate the air in the indoor environment and inside the air conditioning unit itself. The Auto Cleaning function helps to minimise the formation of mould and bacteria on the heat exchanger.

Filtration and Deodorisation



Auto Cleaning

The LG range of high wall splits comes with Auto Cleaning, which dries the coil helping to minimise bacteria, mould and odours that can otherwise accumulate in an indoor unit.



Bacteria Prevention



Odour Minimised

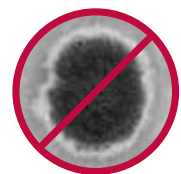

Mould Minimised

KEY FEATURES

WALL MOUNTED

LG Skew Fan

Tilting the fan blades by 15° reduces the air surface pressure on the fan, resulting in reduced peak air noise.

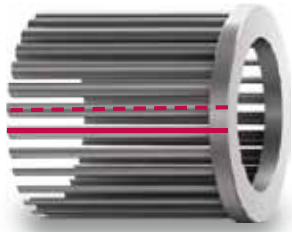

Conventional

When the fan rotates, the stabiliser and the fan blade are parallel (= the contact of lines)

→ Instantaneous pressure charge generates noise.



Skew Fan

When the fan rotates, the stabiliser and the fan blade are not in parallel (= the contact of lines)

→ Instantaneous pressure charge generates noise.

Split Type

Detachable Bottom Cover

Due to the structure of the unit the detachable bottom cover can be removed for easy installation.

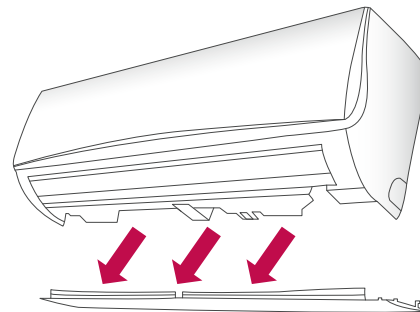

Installation Support Clip

A support clip creates adequate space between the wall and the unit for easier installation.

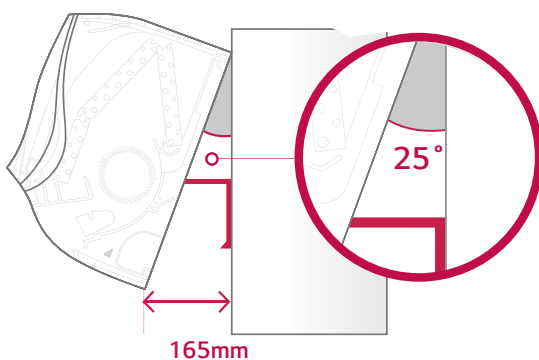

Wider Piping Space

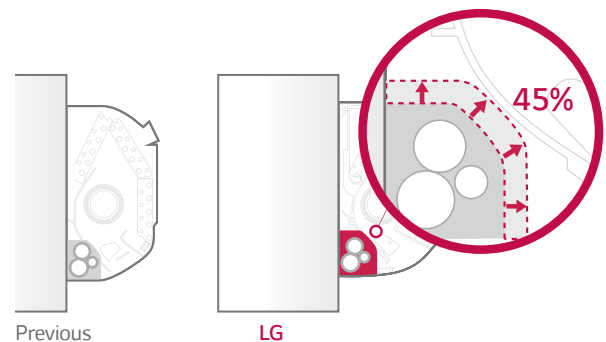

The piping space is up to 45% wider than previous models for easier installation. The piping space is wider than many products currently on the market.



WALL MOUNTED

SPECIFICATIONS

Variety of Indoor Units

Capacity (kW)		2.1	2.6	3.5	5.3	7.0
Wall Mounted Standard		MS07AH2	MS09AH2	MS12AH2	MS18AH2	MS24AH2
Artcool Mirror		NHXM20S2A2	NHXM30S2A2	NHXM40S2A2	NHXM50S2A2	NHXM70S2A2

WALL MOUNTED STANDARD

Model Name		Units	MS07AH2	MS09AH2	MS12AH2	MS18AH2	MS24AH2	
Power Supply		V / Ø / Hz	220-240, 1, 50	220-240, 1, 50	220-240, 1, 50	220-240, 1, 50	220-240, 1, 50	
Capacity	Cooling	kW	2.1	2.6	3.5	5.3	7.0	
	Heating	kW	2.4	3.2	4.0	6.3	7.5	
Power Input	Min. / Norm. / Max.	W	11 / 17 / 30	11 / 18 / 30	11 / 19 / 30	26 / 39 / 60	27 / 45 / 60	
Running Current	Min. / Norm. / Max.	A	0.10 / 0.14 / 0.20	0.10 / 0.16 / 0.20	0.10 / 0.17 / 0.20	0.22 / 0.28 / 0.40	0.24 / 0.33 / 0.40	
Casing Colour		-	Munsell 7.5BG 10/2 (RAL 9016)	Munsell 7.5BG 10/2 (RAL 9016)	Munsell 7.5BG 10/2 (RAL 9016)	Munsell 7.5BG 10/2 (RAL 9016)	Munsell 7.5BG 10/2 (RAL 9016)	
Dimensions	Body	W x H x D	mm	818 x 316 x 189	818 x 316 x 189	818 x 316 x 189	975 x 354 x 209	
	Shipping	W x H x D	mm	892 x 381 x 249	892 x 381 x 249	892 x 381 x 249	1,063 x 420 x 274	
Net Weight	Body	kg (lbs)	8.2 (18.1)	8.2 (18.1)	8.2 (18.1)	10.9 (24.0)	11.5 (25.4)	
	Shipping	kg (lbs)	10.2 (22.5)	10.2 (22.5)	10.2 (22.5)	13.9 (30.6)	14.5 (32.0)	
Heat Exchanger	(Row x Column x Fins) per	-	(2 x 23 x 22) x 1	(2 x 23 x 22) x 1	(2 x 23 x 22) x 1	(2 x 16 x 20) x 1	(2 x 16 x 20) x 1	
	Face Area	m ² (ft ²)	0.20 (2.15)	0.20 (2.15)	0.20 (2.15)	0.24 (2.58)	0.24 (2.58)	
Fan	Type	-	Cross Flow Fan	Cross Flow Fan	Cross Flow Fan	Cross Flow Fan	Cross Flow Fan	
	Air Flow Rate	H / M / L	m ³ / min	7.2 / 5.8 / 4.6	7.6 / 6.2 / 4.8	8.0 / 6.6 / 5.5	15.8 / 12.4 / 10.0	16.9 / 12.8 / 10.4
		H / M / L	L/s	120 / 97 / 76.7	126 / 103 / 80	133 / 110 / 92	263 / 206 / 166	281 / 213 / 173
Fan Motor	Type	-	BLDC	BLDC	BLDC	BLDC	BLDC	
	Output	W x No.	30 x 1	30 x 1	30 x 1	30 x 1	60 x 1	
Sound Pressure Level	H / M / L	dB(A)	35 / 31 / 26	36 / 32 / 27	38 / 34 / 29	44 / 38 / 34	46 / 41 / 36	
Sound Power Level	Max.	dB(A)	56	56	56	59	65	
Piping Connections	Liquid	mm(inch)	Ø 6.35 (1/4)	Ø 6.35 (1/4)	Ø 6.35 (1/4)	Ø 6.35 (1/4)	Ø 6.35 (1/4)	
	Gas	mm(inch)	Ø 9.52 (3/8)	Ø 9.52 (3/8)	Ø 9.52 (3/8)	Ø 12.7 (1/2)	Ø 12.7 (1/2)	
	Drain	(O.D. / I.D.)	mm	21.5 / 16.0	21.5 / 16.0	21.5 / 16.0	21.5 / 16.0	
Safety Devices	-	-	Fuse	Fuse	Fuse	Fuse	Fuse	
	-	-	Thermal Protector for Fan Motor	Thermal Protector for Fan Motor	Thermal Protector for Fan Motor	Thermal Protector for Fan Motor	Thermal Protector for Fan Motor	
Connective Method	-	-	Flared	Flared	Flared	Flared	Flared	
Power & Communication Cable (Included Earth)	No. x mm ² (AWG)	-	4C x 1.0 (18)	4C x 1.0 (18)	4C x 1.0 (18)	4C x 1.0 (18)	4C x 1.0 (18)	

Note : 1. Due to our policy of innovation some specifications may be changed without notification.

2. Capacities are in accordance with AS/NZS3823.1.2

Cooling: - Indoor Temperature 27°C DB / 19°C WB

- Outdoor Temperature 35°C DB / 24°C WB

Heating: - Indoor Temperature 20°C DB / 15°C WB

- Outdoor Temperature 7°C DB / 6°C WB

WALL MOUNTED

SPECIFICATIONS

WALL MOUNTED

ARTCOOL MIRROR

Model Name			Units	NHXM20S2A2	NHXM30S2A2	NHXM40S2A2	NHXM50S2A2	NHXM70S2A2
Power Supply			V / Ø / Hz	220-240, 1, 50	220-240, 1, 50	220-240, 1, 50	220-240, 1, 50	220-240, 1, 50
Capacity	Cooling		kW	2.1	2.6	3.5	5.3	7.0
	Heating		kW	2.4	3.2	4.0	6.3	7.5
Power Input	Min. / Norm / Max.		W	11 / 17 / 30	11 / 18 / 30	11 / 19 / 30	26 / 39 / 60	27 / 45 / 60
Running Current	Min. / Norm / Max.		A	0.10 / 0.14 / 0.20	0.10 / 0.16 / 0.20	0.10 / 0.17 / 0.20	0.22 / 0.28 / 0.40	0.24 / 0.33 / 0.40
Casing Colour			-	Munsell 7.5BP 0.2/20 (RAL 9005)	Munsell 7.5BP 0.2/20 (RAL 9005)	Munsell 7.5BP 0.2/20 (RAL 9005)	Munsell 7.5BP 0.2/20 (RAL 9005)	Munsell 7.5BP 0.2/20 (RAL 9005)
Dimensions	Body	W x H x D	mm	837 x 308 x 192	837 x 308 x 192	837 x 308 x 192	998 x 345 x 212	998 x 345 x 212
	Shipping	W x H x D	mm	909 x 383 x 256	909 x 383 x 256	909 x 383 x 256	1,080 x 422 x 281	1,080 x 422 x 281
Net Weight	Body		kg (lbs)	9.2 (20.3)	9.2 (20.3)	9.2 (20.3)	12.1 (26.7)	12.7 (28.0)
Heat Exchanger	(Row x Column x Fins) per		-	(2 x 23 x 22) x 1	(2 x 23 x 22) x 1	(2 x 23 x 22) x 1	(2 x 16 x 20) x 1	(2 x 16 x 20) x 1
	Face Area		m ² (ft ²)	0.20 (2.15)	0.20 (2.15)	0.20 (2.15)	0.24 (2.58)	0.24 (2.58)
Fan	Type		-	Cross Flow Fan	Cross Flow Fan	Cross Flow Fan	Cross FlowFan	Cross Flow Fan
	Air Flow Rate	H / M / L	m ³ / min	7.2 / 5.8 / 4.6	7.6 / 6.2 / 4.8	8.0 / 6.6 / 5.5	15.8 / 12.4 / 10.0	16.9 / 12.8 / 10.4
		H / M / L	L/s		120 / 96 / 76	126 / 103 / 80	133 / 110 / 92	263 / 206 / 166
Fan Motor	Type		-	BLDC	BLDC	BLDC	BLDC	BLDC
	Output		W x No.	30 x 1	30 x 1	30 x 1	30 x 1	60 x 1
Sound Pressure Level		H / M / L	dB(A)	35 / 31 / 26	36 / 32 / 27	38 / 34 / 29	44 / 38 / 34	46 / 41 / 36
Sound Power Level		Max.	dB(A)	56	56	56	59	65
Piping Connections	Liquid		mm(inch)	Ø 6.35 (1/4)	Ø 6.35 (1/4)	Ø 6.35 (1/4)	Ø 6.35 (1/4)	Ø 6.35 (1/4)
	Gas		mm(inch)	Ø 9.52 (3/8)	Ø 9.52 (3/8)	Ø 9.52 (3/8)	Ø 12.7 (1/2)	Ø 12.7 (1/2)
	Drain	(O.D. / I.D.)	mm	21.5 / 16.0	21.5 / 16.0	21.5 / 16.0	21.5 / 16.0	21.5 / 16.0
Safety Devices			-	Fuse	Fuse	Fuse	Fuse	Fuse
			-	Thermal Protector for Fan Motor	Thermal Protector for Fan Motor	Thermal Protector for Fan Motor	Thermal Protector for Fan Motor	Thermal Protector for Fan Motor
Connective Method			-	Flared	Flared	Flared	Flared	Flared
Power & Communication Cable (Included Earth)			No. x mm ² (AWG)	4C x 1.0 (18)	4C x 1.0 (18)	4C x 1.0 (18)	4C x 1.0 (18)	4C x 1.0 (18)

Note : 1. Due to our policy of innovation some specifications may be changed without notification.

2. Capacities are in accordance with AS/NZS 3823.1.2

Cooling: - Indoor Temperature 27°C DB / 19°C WB

- Outdoor Temperature 35°C DB / 24°C WB

Heating: - Indoor Temperature 20°C DB / 15°C WB

- Outdoor Temperature 7°C DB / 6°C WB

CEILING CASSETTE

SPECIFICATIONS

Variety of indoor units

Capacity (kW)		2.6	3.5
1-Way Cassette Type		NHXM30C1A1	NHXM40C1A1

Model Name			Units	NHXM30C1A1	NHXM40C1A1
Power Supply			V / Ø / Hz	220-240, 1, 50	220-240, 1, 50
Power Input			W x No.	20 x 1	20 x 1
Running Current			A	0.2	0.2
Dimensions	Body	W x H x D	mm	860 x 132 x 450	860 x 132 x 450
Net Weight	Body		kg (lbs)	13.5 (29.8)	13.5 (29.8)
Heat Exchanger	(Row x Column x Fins) per		-	(2 x 12 x 18) x 1	(2 x 12 x 18) x 1
	Face Area		m ² (ft ²)	0.18 (1.90)	0.18 (1.90)
Fan	Type		-	Cross Flow Fan	Cross Flow Fan
	Air Flow Rate	H / M / L	L/s	125 / 122 / 113	135 / 123 / 117
Fan Motor	Type		-	BLDC	BLDC
	Output		W x No.	20 x 1	20 x 1
Sound Pressure Level		H / M / L	dB(A)	36 / 34 / 32	37 / 36 / 33
Piping Connections	Liquid		mm(inch)	Ø 6.35 (1/4)	Ø 6.35 (1/4)
	Gas		mm(inch)	Ø 9.52 (3/8)	Ø 9.52 (3/8)
	Drain	(O.D. / I.D.)	mm	Ø 32.0 / 25.0	Ø 32.0 / 25.0
Safety Devices			-	Fuse	Fuse
			-	Thermal Protector for Fan Motor	Thermal Protector for Fan Motor
Power & Communication Cable (Included Earth)			No. x mm ² (AWG)	4C x 0.75 (18)	4C x 0.75 (18)
Decoration Panel	Model Name		-	PT-UUC1	PT-UUC1
	Casing Colour		-	Morning Fog	Morning Fog
	Dimensions	W x H x D	mm	1,100 x 34 x 500	1,100 x 34 x 500
	Net Weight		kg (lbs)	4.4 (9.7)	4.4 (9.7)

Note: 1. Due to our policy of innovation some specifications may be changed without notification.

2. Capacities are in accordance with AS/NZS3823.1.2

Cooling: - Indoor Temperature 27°C DB / 19°C WB

- Outdoor Temperature 35°C DB / 24°C WB

Heating: - Indoor Temperature 20°C DB / 15°C WB

- Outdoor Temperature 7°C DB / 6°C WB

CEILING CONCEALED DUCT

E.S.P: (External Static Pressure) Control

E.S.P. control function can make air volume controlled easily with remote controller. The BLDC motor can control fan speed and air volume regardless of the external static pressure. No additional accessories are necessary to control air flow.

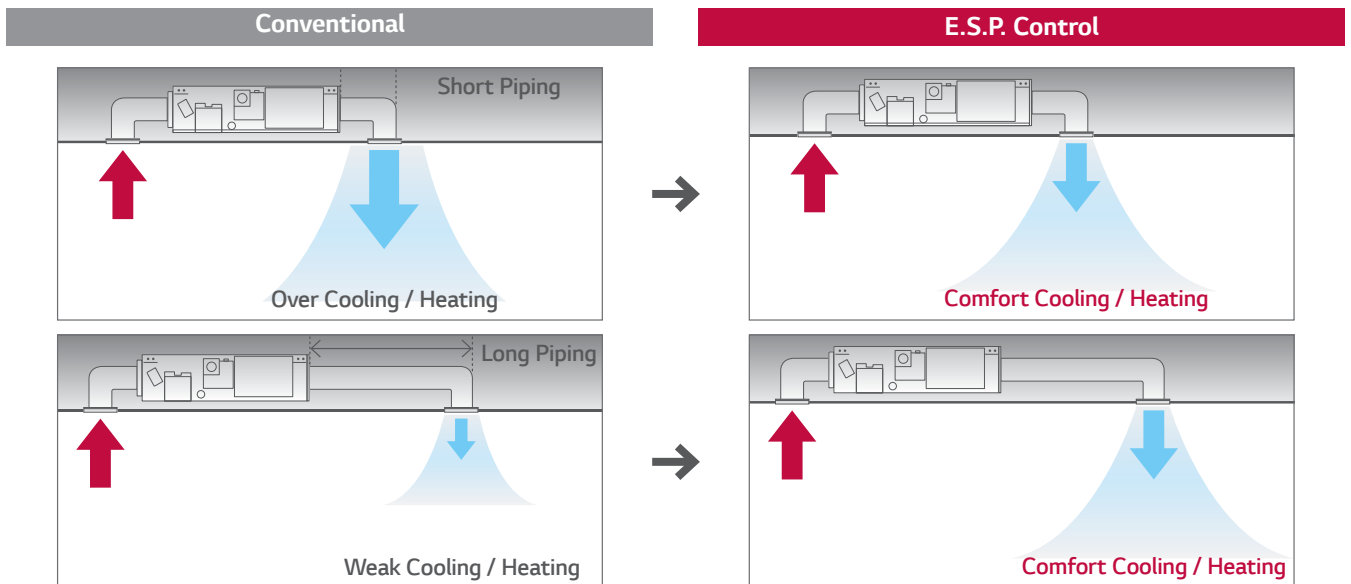

Easy Service & Maintenance

Users don't need to open whole panel for maintenance, since panel is divided into one for heat exchanger and one for fan/motor. Easily detach and attach the filter even in limited space.

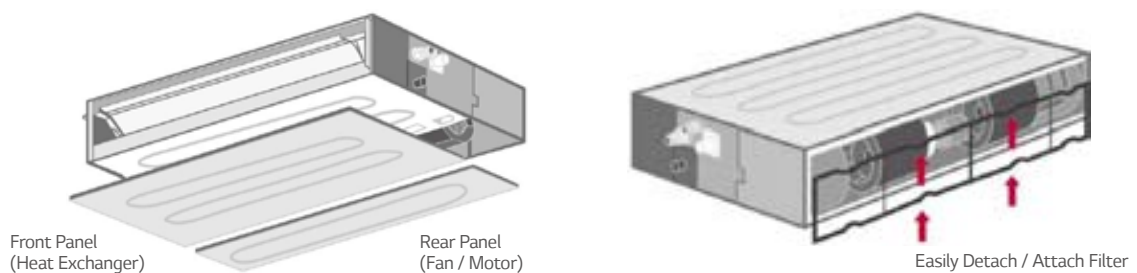

Drain Pump

An auxiliary condensate drain pump is available as an option for all LG ducted indoor units. This is an ideal solution where drain fall is limited or unavailable. This will lift water up to a 700mm height above the drain outlet.

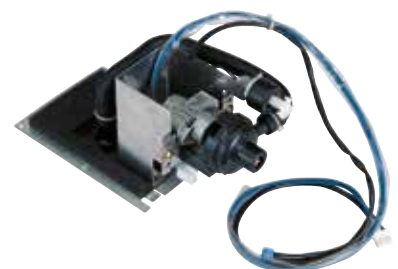

CEILING CONCEALED DUCT

SPECIFICATIONS

Various indoor units

Capacity (kW)		2.6	3.5	5.3	7.0
Low Static Duct		NHXM30D3A1	NHXM40D3A1	NHXM50D3A1	NHXM70D3A1

Model Name			Units	NHXM30D3A1	NHXM40D3A1	NHXM50D3A1	NHXM70D3A1	
Power Supply			Ø / V / Hz	1 / 220-240 / 50	1 / 220-240 / 50	1 / 220-240 / 50	1 / 220-240 / 50	
Power Input			W	50	95	120	150	
Running Current			A	0.4	0.8	0.8	1.0	
Dimensions	Body	W x H x D	mm	700 x 190 x 700	900 x 190 x 700	900 x 190 x 700	1,100 x 190 x 700	
Net Weight	Body		kg (lbs)	17.5 (38.6)	24.0 (50.7)	24.0 (50.7)	27 (59.5)	
Heat Exchange	(Row x Column x Fins per inch) x No.		-	(2 x 11 x 14) x 1	(2 x 11 x 18) x 1	(2 x 11 x 18) x 1	(3 x 11 x 18) x 1	
	Face Area		m ² (ft ²)	0.12 (1.32)	0.17 (1.81)	0.17 (1.81)	0.21 (2.31)	
Fan	Type		-	Sirocco	Sirocco	Sirocco	Sirocco	
	Air Flow Rate	High-static Mode (factory set)	H / M / L	L/s	150 / 117 / 92	167 / 142 / 117	250 / 208 / 166	333 / 266 / 200
			External Static Pressure	Pa (mmAq)	24.5 (2.5)	24.5 (2.5)	24.5 (2.5)	24.5 (2.5)
Fan Motor	Type		-	BLDC	BLDC	BLDC	BLDC	
	Output		W x No.	19 x 1	19 x 1 + 5 x 1	19 x 1 + 5 x 1	19 x 2	
Sound Pressure Level		H / M / L	dB(A)	30 / 26 / 23	31 / 28 / 27	36 / 34 / 31	39 / 35 / 32	
Sound Power Level		Max.	dB(A)	49	52	54	58	
Piping Connections	Liquid		mm (inch)	Ø 6.35 (1/4)	Ø 6.35 (1/4)	Ø 6.35 (1/4)	Ø 6.35 (1/4)	
	Gas		mm (inch)	Ø 9.52 (3/8)	Ø 9.52 (3/8)	Ø 12.7 (1/2)	Ø 12.7 (1/2)	
	Drain (O.D. / I.D.)		mm	Ø 32 / 25	Ø 32 / 25	Ø 32 / 25	Ø 32 / 25	
Safety Devices			-	Fuse	Fuse	Fuse	Fuse	
Power and Communication Cable (Included Earth)			No. x mm ² (AWG)	4C x 0.75 (18)	4C x 0.75 (18)	4C x 0.75 (18)	4C x 0.75 (18)	

Note : 1. Due to our policy of innovation some specifications may be changed without notification.

2. Capacities are in accordance with AS/NZS3823.1.2

Cooling: - Indoor Temperature 27°C DB / 19°C WB

- Outdoor Temperature 35°C DB / 24°C WB

Heating: - Indoor Temperature 20°C DB / 15°C WB

- Outdoor Temperature 7°C DB / 6°C WB

Multiple Combinations



4 Outdoor Units

16 Indoor Units

* Across Multi F range.

COMBINATION TABLE

UHXM55MA1

Operation	Combination (kW)				Cooling								
					Each Capacity (kW)			Total Capacity (kW)			Total Input (W)		
	UINT-A	UINT-B	UINT-C	Total	UINT-A	UINT-B	UINT-C	Min	Rated	Max	Min	Rated	Max
1Unit	7	-	-	7	2.1	-	-	1.3	2.1	2.5	196	502	809
	9	-	-	9	2.6	-	-	1.6	2.6	3.2	252	645	1,040
	12	-	-	12	3.5	-	-	2.1	3.5	4.2	336	860	1,387
	18	-	-	18	5.3	-	-	3.2	5.3	6.3	504	1,290	2,080
2Unit	7	7	-	14	2.1	2.1	-	2.5	4.1	4.9	392	1,003	1,618
	7	9	-	16	2.1	2.6	-	2.8	4.7	5.6	448	1,147	1,849
	9	9	-	18	2.6	2.6	-	3.2	5.3	6.3	504	1,290	2,080
	7	12	-	19	1.9	3.3	-	3.2	5.3	6.3	504	1,290	2,080
	9	12	-	21	2.3	3.0	-	3.2	5.3	6.3	504	1,290	2,080
	12	12	-	24	2.6	2.6	-	3.2	5.3	6.3	504	1,290	2,080
	7	18	-	25	1.5	3.8	-	3.2	5.3	6.3	504	1,290	2,080
	9	18	-	27	1.8	3.5	-	3.2	5.3	6.3	504	1,290	2,080
3Unit	12	18	-	30	2.1	3.2	-	3.2	5.3	6.3	504	1,290	2,080
	7	7	7	21	1.8	1.8	1.8	3.2	5.3	6.3	504	1,290	2,080
	7	7	9	23	1.6	1.6	2.1	3.2	5.3	6.3	504	1,290	2,080
	7	9	9	25	1.5	1.9	1.9	3.2	5.3	6.3	504	1,290	2,080
	7	7	12	26	1.4	1.4	2.4	3.2	5.3	6.3	504	1,290	2,080
	9	9	9	27	1.8	1.8	1.8	3.2	5.3	6.3	504	1,290	2,080
	7	9	12	28	1.3	1.7	2.3	3.2	5.3	6.3	504	1,290	2,080
	9	9	12	30	1.6	1.6	2.1	3.2	5.3	6.3	504	1,290	2,080

Note :

1. Cooling Capacity is based on : indoor temp.27°CDB, 19°CWB ; outdoor temp. 35°CDB
2. Heating Capacity is based on : indoor temp.20°CDB ; outdoor temp. 7°CDB, 6°CWB
3. The total ability of connected a indoor unit is up to 8.78kW
4. At least two indoor units should be connected.

Operation	Combination (kW)				Heating								
					Each Capacity (kW)			Total Capacity (kW)			Total Input (W)		
	UINT-A	UINT-B	UINT-C	Total	UINT-A	UINT-B	UINT-C	Min	Rated	Max	Min	Rated	Max
1Unit	7	-	-	7	2.5	-	-	1.4	2.5	2.8	196	502	809
	9	-	-	9	3.2	-	-	1.9	3.2	3.6	252	645	1,040
	12	-	-	12	4.2	-	-	2.5	4.2	4.9	336	860	1,387
	18	-	-	18	6.3	-	-	3.8	6.3	7.3	504	1,290	2,080
2Unit	7	7	-	14	2.5	2.5	-	3.0	4.9	5.7	392	1,003	1,618
	7	9	-	16	2.5	3.2	-	3.4	5.6	6.5	448	1,147	1,849
	9	9	-	18	3.2	3.2	-	3.8	6.3	7.3	504	1,290	2,080
	7	12	-	19	2.3	4.0	-	3.8	6.3	7.3	598	1,530	2,467
	9	12	-	21	3.2	4.2	-	4.4	7.4	8.5	598	1,530	2,467
	12	12	-	24	3.2	3.2	-	3.8	6.3	7.3	598	1,530	2,467
	7	18	-	25	1.8	4.6	-	3.8	6.3	7.3	598	1,530	2,467
	9	18	-	27	2.1	4.2	-	3.8	6.3	7.3	598	1,530	2,467
3Unit	12	18	-	30	2.5	3.8	-	3.8	6.3	7.3	598	1,530	2,467
	7	7	7	21	2.1	2.1	2.1	3.8	6.3	7.3	598	1,530	2,467
	7	7	9	23	1.9	1.9	2.5	3.8	6.3	7.3	598	1,530	2,467
	7	9	9	25	1.8	2.3	2.3	3.8	6.3	7.3	598	1,530	2,467
	7	7	12	26	1.7	1.7	2.9	3.8	6.3	7.3	598	1,530	2,467
	9	9	9	27	2.1	2.1	2.1	3.8	6.3	7.3	598	1,530	2,467
	7	9	12	28	1.6	2.0	2.7	3.8	6.3	7.3	598	1,530	2,467
	9	9	12	30	1.9	1.9	2.5	3.8	6.3	7.3	598	1,530	2,640

Note :

1. Cooling Capacity is based on : indoor temp.27°CDB, 19°CWB ; outdoor temp. 35°CDB
2. Heating Capacity is based on : indoor temp.20°CDB ; outdoor temp. 7°CDB, 6°CWB
3. The total ability of connected a indoor unit is up to 8.78kW
4. At least two indoor units should be connected.

COMBINATION TABLE

UHXM70MA1

Operation	Combination (kW)					Cooling									
						Each Capacity (kW)				Total Capacity (kW)			Total Input (W)		
	UNIT-A	UNIT-B	UNIT-C	UNIT-D	Total	UNIT-A	UNIT-B	UNIT-C	UNIT-D	Min	Rated	Max	Min	Rated	Max
1Unit	7	-	-	-	7	2.1	-	-	-	1.8	2.1	2.3	444	740	1,029
	9	-	-	-	9	2.6	-	-	-	1.8	2.6	2.9	540	900	1,167
	12	-	-	-	12	3.5	-	-	-	2.1	3.5	3.9	660	1,100	1,294
	18	-	-	-	18	5.3	-	-	-	3.2	5.3	5.8	1,020	1,700	2,225
	24	-	-	-	24	7.0	-	-	-	4.2	7.0	7.5	1,470	2,450	3,088
2Unit	7	7	-	-	14	2.1	2.1	-	-	2.5	4.1	4.5	492	820	980
	7	9	-	-	16	2.1	2.6	-	-	2.8	4.7	5.2	636	1,060	1,294
	9	9	-	-	18	2.6	2.6	-	-	3.2	5.3	5.8	810	1,350	1,676
	7	12	-	-	19	2.1	3.5	-	-	3.3	5.6	6.1	924	1,540	1,843
	9	12	-	-	21	2.6	3.5	-	-	3.7	6.2	6.8	1,128	1,880	2,441
	12	12	-	-	24	3.4	3.4	-	-	4.0	6.7	7.5	1,374	2,290	2,854
	7	18	-	-	25	2.0	5.1	-	-	4.2	7.0	7.8	1,410	2,350	3,147
	9	18	-	-	27	2.3	4.7	-	-	4.2	7.0	8.1	1,410	2,350	3,147
	12	18	-	-	30	2.8	4.2	-	-	4.2	7.0	8.4	1,410	2,350	3,147
	7	24	-	-	31	1.6	5.4	-	-	4.2	7.0	8.5	1,410	2,350	3,147
	9	24	-	-	33	1.9	5.1	-	-	4.2	7.0	8.5	1,410	2,350	3,147
	18	18	-	-	36	3.5	3.5	-	-	4.2	7.0	8.5	1,410	2,350	3,147
	12	24	-	-	36	2.3	4.7	-	-	4.2	7.0	8.5	1,410	2,350	3,147
3Unit	7	7	7	-	21	2.1	2.1	2.1	-	3.7	6.2	7.4	738	1,230	1,588
	7	7	9	-	23	2.1	2.1	2.6	-	4.0	6.7	8.1	912	1,520	1,814
	7	9	9	-	25	2.0	2.5	2.5	-	4.2	7.0	8.4	990	1,650	1,971
	7	7	12	-	26	1.9	1.9	3.2	-	4.2	7.0	8.4	990	1,650	1,971
	9	9	9	-	27	2.3	2.3	2.3	-	4.2	7.0	8.4	990	1,650	1,971
	7	9	12	-	28	1.8	2.3	3.0	-	4.2	7.0	8.4	990	1,650	1,971
	9	9	12	-	30	2.1	2.1	2.8	-	4.2	7.0	8.4	990	1,650	1,971
	7	12	12	-	31	1.6	2.7	2.7	-	4.2	7.0	8.4	990	1,650	1,971
	7	7	18	-	32	1.5	1.5	4.0	-	4.2	7.0	8.4	990	1,650	1,971
	9	12	12	-	33	1.9	2.6	2.6	-	4.2	7.0	8.4	990	1,650	1,971
	7	9	18	-	34	1.4	1.9	3.7	-	4.2	7.0	8.4	990	1,650	1,971
	12	12	12	-	36	2.3	2.3	2.3	-	4.2	7.0	8.4	990	1,650	1,971
	9	9	18	-	36	1.8	1.8	3.5	-	4.2	7.0	8.4	990	1,650	1,971
	7	12	18	-	37	1.3	2.3	3.4	-	4.2	7.0	8.4	990	1,650	1,971
	7	7	24	-	38	1.3	1.3	4.4	-	4.2	7.0	8.4	990	1,650	1,971
9	12	18	-	39	1.6	2.2	3.2	-	4.2	7.0	8.4	990	1,650	1,971	
4Unit	7	7	7	7	28	1.8	1.8	1.8	1.8	4.2	7.0	8.4	990	1,670	2,510
	7	7	7	9	30	1.6	1.6	1.6	2.1	4.2	7.0	8.5	990	1,670	2,590
	7	7	9	9	32	1.5	1.5	2.0	2.0	4.2	7.0	8.5	990	1,670	2,590
	7	7	7	12	33	1.5	1.5	1.5	2.6	4.2	7.0	8.5	990	1,670	2,590
	7	9	9	9	34	1.4	1.9	1.9	1.9	4.2	7.0	8.5	990	1,670	2,590
	7	7	9	12	35	1.4	1.4	1.8	2.4	4.2	7.0	8.5	990	1,670	2,590
	9	9	9	9	36	1.8	1.8	1.8	1.8	4.2	7.0	8.5	990	1,670	2,590
	7	9	9	12	37	1.3	1.7	1.7	2.3	4.2	7.0	8.5	990	1,670	2,590
	7	7	12	12	38	1.3	1.3	2.2	2.2	4.2	7.0	8.5	990	1,670	2,590
	9	9	9	12	39	1.6	1.6	1.6	2.2	4.2	7.0	8.5	990	1,670	2,590
	7	7	7	18	39	1.3	1.3	1.3	3.2	4.2	7.0	8.5	990	1,670	2,590

Note :

1. Cooling Capacity is based on : indoor temp.27°CDB, 19°CWB ; outdoor temp. 35°CDB
2. Heating Capacity is based on : indoor temp.20°CDB ; outdoor temp. 7°CDB, 6°CWB
3. The total ability of connected a indoor unit is up to 11.42kW
4. At least two indoor units should be connected.

Operation	Combination (kW)					Heating									
						Each Capacity (kW)				Total Capacity (kW)			Total Input (W)		
	UNIT-A	UNIT-B	UNIT-C	UNIT-D	Total	UNIT-A	UNIT-B	UNIT-C	UNIT-D	Min	Rated	Max	Min	Rated	Max
1Unit	7	-	-	-	7	2.3	-	-	-	2.2	2.3	2.6	510	850	1,294
	9	-	-	-	9	2.9	-	-	-	2.2	2.9	3.2	534	890	1,471
	12	-	-	-	12	3.9	-	-	-	2.3	3.9	4.2	582	970	1,676
	18	-	-	-	18	5.8	-	-	-	3.5	5.8	6.4	1,152	1,920	2,157
	24	-	-	-	24	7.4	-	-	-	4.5	7.4	7.8	1,416	2,360	3,431
2Unit	7	7	-	-	14	2.5	2.5	-	-	3.0	4.9	5.4	762	1,270	2,507
	7	9	-	-	16	2.5	3.2	-	-	3.4	5.6	6.2	834	1,390	2,167
	9	9	-	-	18	3.2	3.2	-	-	3.8	6.3	6.9	1,104	1,840	2,931
	7	12	-	-	19	2.5	4.2	-	-	4.0	6.7	7.3	1,206	2,010	3,039
	9	12	-	-	21	3.2	4.2	-	-	4.4	7.4	8.1	1,356	2,260	3,225
	12	12	-	-	24	3.9	3.9	-	-	4.6	7.7	8.5	1,608	2,680	3,412
	7	18	-	-	25	2.3	5.9	-	-	4.9	8.1	8.8	1,608	2,680	3,412
	9	18	-	-	27	2.8	5.6	-	-	5.1	8.4	9.2	1,608	2,680	3,412
	12	18	-	-	30	3.4	5.1	-	-	5.1	8.4	9.4	1,608	2,680	3,412
	7	24	-	-	31	1.9	6.5	-	-	5.1	8.4	9.4	1,608	2,680	3,412
	9	24	-	-	33	2.3	6.1	-	-	5.1	8.4	9.4	1,608	2,680	3,412
	18	18	-	-	36	4.2	4.2	-	-	5.1	8.4	9.4	1,608	2,680	3,412
	12	24	-	-	36	2.8	5.6	-	-	5.1	8.4	9.4	1,608	2,680	3,412
3Unit	7	7	7	-	21	2.5	2.5	2.5	-	4.4	7.4	8.1	1,026	1,710	2,873
	7	7	9	-	23	2.5	2.5	3.2	-	4.9	8.1	8.8	1,122	1,870	3,275
	7	9	9	-	25	2.4	3.0	3.0	-	5.1	8.4	8.8	1,188	1,980	3,647
	7	7	12	-	26	2.3	2.3	3.9	-	5.1	8.4	9.2	1,188	1,980	3,647
	9	9	9	-	27	2.8	2.8	2.8	-	5.1	8.4	9.2	1,188	1,980	3,647
	7	9	12	-	28	2.1	2.7	3.6	-	5.1	8.4	9.4	1,188	1,980	3,647
	9	9	12	-	30	2.5	2.5	3.4	-	5.1	8.4	9.4	1,188	1,980	3,647
	7	12	12	-	31	1.9	3.3	3.3	-	5.1	8.4	9.4	1,188	1,980	3,647
	7	7	18	-	32	1.8	1.8	4.7	-	5.1	8.4	9.4	1,188	1,980	3,647
	9	12	12	-	33	2.3	3.1	3.1	-	5.1	8.4	9.4	1,188	1,980	3,647
	7	9	18	-	34	1.7	2.2	4.5	-	5.1	8.4	9.4	1,188	1,980	3,647
	12	12	12	-	36	2.8	2.8	2.8	-	5.1	8.4	9.4	1,188	1,980	3,647
	9	9	18	-	36	2.1	2.1	4.2	-	5.1	8.4	9.4	1,188	1,980	3,647
	7	12	18	-	37	1.6	2.7	4.1	-	5.1	8.4	9.4	1,188	1,980	3,647
	7	7	24	-	38	1.6	1.6	5.3	-	5.1	8.4	9.4	1,188	1,980	3,647
9	12	18	-	39	1.9	2.6	3.9	-	5.1	8.4	9.4	1,188	1,980	3,647	
4Unit	7	7	7	7	28	2.1	2.1	2.1	2.1	5.1	8.4	9.2	1,110	1,800	2,910
	7	7	7	9	30	2.0	2.0	2.0	2.5	5.1	8.4	9.4	1,110	1,800	2,990
	7	7	9	9	32	1.8	1.8	2.4	2.4	5.1	8.4	9.4	1,110	1,800	2,990
	7	7	7	12	33	1.8	1.8	1.8	3.1	5.1	8.4	9.4	1,110	1,800	2,990
	7	9	9	9	34	1.7	2.2	2.2	2.2	5.1	8.4	9.4	1,110	1,800	2,990
	7	7	9	12	35	1.7	1.7	2.2	2.9	5.1	8.4	9.4	1,110	1,800	2,990
	9	9	9	9	36	2.1	2.1	2.1	2.1	5.1	8.4	9.4	1,110	1,800	2,990
	7	9	9	12	37	1.6	2.1	2.1	2.7	5.1	8.4	9.4	1,110	1,800	2,990
	7	7	12	12	38	1.6	1.6	2.7	2.7	5.1	8.4	9.4	1,110	1,800	2,990
	9	9	9	12	39	1.9	1.9	1.9	2.6	5.1	8.4	9.4	1,110	1,800	2,990
7	7	7	18	39	1.5	1.5	1.5	3.9	5.1	8.4	9.4	1,110	1,800	2,990	

Note :

1. Cooling Capacity is based on : indoor temp.27°CDB, 19°CWB ; outdoor temp. 35°CDB
2. Heating Capacity is based on : indoor temp.20°CDB ; outdoor temp. 7°CDB, 6°CWB
3. The total ability of connected a indoor unit is up to 11.42kW
4. At least two indoor units should be connected.

COMBINATION TABLE

UHXM90MA1

Operation	Combination (kW)						Cooling										
	UNIT-A	UNIT-B	UNIT-C	UNIT-D	UNIT-E	Total	Each Capacity (kW)				Total Capacity (kW)			Total Input (W)			
	UNIT-A	UNIT-B	UNIT-C	UNIT-D	UNIT-E	Total	UNIT-A	UNIT-B	UNIT-C	UNIT-D	UNIT-E	Min	Rated	Max	Min	Rated	Max
1Unit	7	-	-	-	-	7	2.1	-	-	-	-	1.9	2.1	2.3	444	740	1,029
	9	-	-	-	-	9	2.6	-	-	-	-	1.9	2.6	2.9	540	900	1,167
	12	-	-	-	-	12	3.5	-	-	-	-	2.1	3.5	3.9	660	1,100	1,294
	18	-	-	-	-	18	5.3	-	-	-	-	3.2	5.3	5.8	1,020	1,700	2,225
	24	-	-	-	-	24	7.0	-	-	-	-	4.2	7.1	7.5	1,470	2,450	3,088
2Unit	7	7	-	-	-	14	2.1	2.1	-	-	-	2.5	4.1	4.7	492	820	980
	7	9	-	-	-	16	2.1	2.6	-	-	-	2.8	4.7	5.4	636	1,060	1,294
	9	9	-	-	-	18	2.6	2.6	-	-	-	3.2	5.3	6.1	810	1,350	1,676
	7	12	-	-	-	19	2.1	3.5	-	-	-	3.4	5.6	6.1	924	1,540	1,843
	9	12	-	-	-	21	2.6	3.5	-	-	-	3.7	6.2	6.8	1,128	1,880	2,441
	12	12	-	-	-	24	3.5	3.5	-	-	-	4.2	7.1	7.8	1,410	2,350	3,147
	7	18	-	-	-	25	2.1	5.3	-	-	-	4.4	7.4	8.5	1,542	2,570	3,304
	9	18	-	-	-	27	2.6	5.3	-	-	-	4.8	7.9	9.1	1,770	2,950	3,586
	12	18	-	-	-	30	3.5	5.3	-	-	-	5.3	8.8	9.7	1,950	3,250	3,667
	7	24	-	-	-	31	2.0	6.8	-	-	-	5.3	8.8	9.7	1,950	3,250	3,667
	9	24	-	-	-	33	2.4	6.4	-	-	-	5.3	8.8	9.7	1,950	3,250	3,667
3Unit	7	7	7	-	-	21	2.1	2.1	2.1	-	-	3.7	6.2	7.1	738	1,230	1,588
	7	7	9	-	-	23	2.1	2.1	2.6	-	-	4.1	6.8	7.8	912	1,520	1,814
	7	9	9	-	-	25	2.1	2.6	2.6	-	-	4.4	7.4	8.5	1,080	1,800	2,167
	7	7	12	-	-	26	2.1	2.1	3.5	-	-	4.6	7.6	8.8	1,176	1,960	2,529
	9	9	9	-	-	27	2.6	2.6	2.6	-	-	4.8	7.9	9.1	1,248	2,080	2,647
	7	9	12	-	-	28	2.1	2.6	3.5	-	-	4.9	8.2	9.5	1,338	2,230	2,794
	9	9	12	-	-	30	2.6	2.6	3.5	-	-	5.3	8.8	9.9	1,584	2,640	3,206
	7	12	12	-	-	31	2.0	3.4	3.4	-	-	5.3	8.8	9.9	1,584	2,640	3,206
	7	7	18	-	-	32	1.9	1.9	4.9	-	-	5.3	8.8	10.1	1,584	2,640	3,206
	9	12	12	-	-	33	2.4	3.2	3.2	-	-	5.3	8.8	9.9	1,584	2,640	3,206
	7	9	18	-	-	34	1.8	2.3	4.7	-	-	5.3	8.8	10.1	1,584	2,640	3,206
4Unit	7	7	7	7	-	28	2.1	2.1	2.1	2.1	-	4.9	8.2	9.9	1,224	2,040	3,137
	7	7	7	9	-	30	2.1	2.1	2.1	2.6	-	5.3	8.8	10.6	1,350	2,250	3,422
	7	7	9	9	-	32	1.9	1.9	2.5	2.5	-	5.3	8.8	10.6	1,350	2,250	3,422
	7	9	9	9	-	34	1.8	2.3	2.3	2.3	-	5.3	8.8	10.6	1,350	2,250	3,422
	7	7	9	12	-	35	1.8	1.8	2.3	3.0	-	5.3	8.8	10.6	1,350	2,250	3,422
	9	9	9	9	-	36	2.2	2.2	2.2	2.2	-	5.3	8.8	10.6	1,350	2,250	3,422
	7	9	9	12	-	37	1.7	2.1	2.1	2.9	-	5.3	8.8	10.6	1,350	2,250	3,422
	7	7	12	12	-	38	1.6	1.6	2.8	2.8	-	5.3	8.8	10.1	1,350	2,250	3,422
	9	9	9	12	-	39	2.0	2.0	2.0	2.7	-	5.3	8.8	10.6	1,350	2,250	3,422
	7	7	7	18	-	39	1.6	1.6	1.6	4.1	-	5.3	8.8	10.6	1,350	2,250	3,422
	7	9	12	12	-	40	1.5	2.0	2.6	2.6	-	5.3	8.8	10.1	1,350	2,250	3,422
4Unit	7	7	9	18	-	41	1.5	1.5	1.9	3.9	-	5.3	8.8	10.6	1,350	2,250	3,422
	9	9	12	12	-	42	1.9	1.9	2.5	2.5	-	5.3	8.8	10.6	1,350	2,250	3,422
	7	12	12	12	-	43	1.4	2.5	2.5	2.5	-	5.3	8.8	10.1	1,350	2,250	3,422
	7	9	9	18	-	43	1.4	1.8	1.8	3.7	-	5.3	8.8	10.6	1,350	2,250	3,422
	7	7	12	18	-	44	1.4	1.4	2.4	3.6	-	5.3	8.8	10.6	1,350	2,250	3,422
	9	12	12	12	-	45	1.8	2.3	2.3	2.3	-	5.3	8.8	10.1	1,350	2,250	3,422
	9	9	9	18	-	45	1.8	1.8	1.8	3.5	-	5.3	8.8	10.6	1,350	2,250	3,422
	7	9	12	18	-	46	1.3	1.7	2.3	3.4	-	5.3	8.8	10.6	1,350	2,250	3,422
	7	7	9	24	-	47	1.3	1.3	1.7	4.5	-	5.3	8.8	10.1	1,350	2,250	3,422
	12	12	12	12	-	48	2.2	2.2	2.2	2.2	-	5.3	8.8	10.6	1,350	2,250	3,422
	9	9	12	18	-	48	1.6	1.6	2.2	3.3	-	5.3	8.8	10.6	1,350	2,250	3,422
	7	12	12	18	-	49	1.3	2.2	2.2	3.2	-	5.3	8.8	10.1	1,350	2,250	3,422
	7	9	9	24	-	49	1.3	1.6	1.6	4.3	-	5.3	8.8	10.6	1,350	2,250	3,422
	7	7	12	24	-	50	1.2	1.2	2.1	4.2	-	5.3	8.8	10.6	1,350	2,250	3,422
9	12	12	18	-	50	1.2	1.2	3.2	3.2	-	5.3	8.8	10.1	1,350	2,250	3,422	
9	9	9	24	-	51	1.6	1.6	1.6	4.1	-	5.3	8.8	10.6	1,350	2,250	3,422	
7	9	12	24	-	52	1.2	1.5	2.0	3.9	-	5.3	8.8	10.6	1,350	2,250	3,422	
9	9	12	24	-	52	1.5	1.5	2.9	3.9	-	5.3	8.8	10.1	1,350	2,250	3,422	
9	9	18	18	-	54	1.5	1.5	2.9	2.9	-	5.3	8.8	10.6	1,350	2,250	3,422	
12	12	12	18	-	54	2.0	2.0	2.0	2.9	-	5.3	8.8	10.6	1,350	2,250	3,422	

Note :

1. Cooling Capacity is based on : indoor temp.27°CDB, 19°CWB ; outdoor temp. 35°CDB / 2. Heating Capacity is based on : indoor temp.20°CDB ; outdoor temp. 7°CDB, 6°CWB 3. The total ability of connected a indoor unit is up to 14kW / 4. At least two indoor units should be connected.

UHXM90MA1

Operation	Combination (kW)						Cooling											
							Each Capacity (kW)					Total Capacity (kW)			Total Input (W)			
							UNIT-A	UNIT-B	UNIT-C	UNIT-D	UNIT-E	Total	UNIT-A	UNIT-B	UNIT-C	UNIT-D	UNIT-E	Min
5Unit	7	7	7	7	7	35	1.8	1.8	1.8	1.8	1.8	5.3	8.8	10.6	1,280	2,200	3,380	
	7	7	7	7	9	37	1.7	1.7	1.7	1.7	2.1	5.3	8.8	10.6	1,280	2,200	3,380	
	7	7	7	9	9	39	1.6	1.6	1.6	2.0	2.0	5.3	8.8	10.6	1,280	2,200	3,380	
	7	7	7	7	12	40	1.5	1.5	1.5	1.5	2.6	5.3	8.8	10.6	1,280	2,200	3,380	
	7	7	9	9	9	41	1.5	1.5	1.9	1.9	1.9	5.3	8.8	10.6	1,280	2,200	3,380	
	7	7	7	9	12	42	1.5	1.5	1.5	1.9	2.5	5.3	8.8	10.6	1,280	2,200	3,380	
	7	9	9	9	9	43	1.4	1.8	1.8	1.8	1.8	5.3	8.8	10.6	1,280	2,200	3,380	
	7	7	9	9	12	44	1.4	1.4	1.8	1.8	2.4	5.3	8.8	10.6	1,280	2,200	3,380	
	9	9	9	9	9	45	1.8	1.8	1.8	1.8	1.8	5.3	8.8	10.6	1,280	2,200	3,380	
	7	7	7	7	18	46	1.3	1.3	1.3	1.3	3.4	5.3	8.8	10.6	1,280	2,200	3,380	
	7	9	9	9	12	46	1.3	1.7	1.7	1.7	2.3	5.3	8.8	10.6	1,280	2,200	3,380	
	7	7	9	12	12	47	1.3	1.3	1.7	2.2	2.2	5.3	8.8	10.6	1,280	2,200	3,380	
	9	9	9	9	12	48	1.6	1.6	1.6	1.6	2.2	5.3	8.8	10.6	1,280	2,200	3,380	
	7	7	7	9	18	48	1.3	1.3	1.3	1.6	3.3	5.3	8.8	10.6	1,280	2,200	3,380	
	7	9	9	12	12	49	1.3	1.6	1.6	2.2	2.2	5.3	8.8	10.6	1,280	2,200	3,380	
	7	7	12	12	12	50	1.2	1.2	2.1	2.1	2.1	5.3	8.8	10.6	1,280	2,200	3,380	
	7	7	9	9	18	50	1.2	1.2	1.6	1.6	3.2	5.3	8.8	10.6	1,280	2,200	3,380	
	9	9	9	12	12	51	1.6	1.6	1.6	2.1	2.1	5.3	8.8	10.6	1,280	2,200	3,380	
	7	7	7	12	18	51	1.2	1.2	1.2	2.1	3.1	5.3	8.8	10.6	1,280	2,200	3,380	
	7	9	12	12	12	52	1.2	1.5	2.0	2.0	2.0	5.3	8.8	10.6	1,280	2,200	3,380	
	7	9	9	9	18	52	1.3	1.5	1.5	1.5	3.0	5.3	8.8	10.6	1,280	2,200	3,380	
	7	7	7	7	24	52	1.2	1.2	1.2	1.2	4.1	5.3	8.8	10.6	1,280	2,200	3,380	
	7	7	9	12	18	53	1.2	1.2	1.5	2.0	3.0	5.3	8.8	10.6	1,280	2,200	3,380	
	7	7	7	9	24	54	1.1	1.1	1.1	1.5	3.9	5.3	8.8	10.6	1,280	2,200	3,380	
	9	9	9	9	18	54	1.5	1.5	1.5	1.5	2.9	5.3	8.8	10.6	1,280	2,200	3,380	
	9	9	12	12	12	54	1.5	1.5	2.0	2.0	2.0	5.3	8.8	10.6	1,280	2,200	3,380	

Operation	Combination (kW)						Heating											
							Each Capacity (kW)					Total Capacity (kW)			Total Input (W)			
							UNIT-A	UNIT-B	UNIT-C	UNIT-D	UNIT-E	Total	UNIT-A	UNIT-B	UNIT-C	UNIT-D	UNIT-E	Min
1Unit	7	-	-	-	-	7	2.3	-	-	-	-	2.2	2.3	2.6	510	850	1,294	
	9	-	-	-	-	9	2.9	-	-	-	-	2.2	2.9	3.2	534	890	1,471	
	12	-	-	-	-	12	3.9	-	-	-	-	2.3	3.9	4.3	582	970	1,676	
	18	-	-	-	-	18	5.8	-	-	-	-	3.5	5.8	6.4	1,152	1,920	2,157	
	24	-	-	-	-	24	7.4	-	-	-	-	4.5	7.4	7.8	1,416	2,360	3,431	
2Unit	7	7	-	-	-	14	2.5	2.5	-	-	-	3.0	4.9	5.7	762	1,270	2,507	
	7	9	-	-	-	16	2.5	3.2	-	-	-	3.4	5.6	6.5	834	1,390	2,167	
	9	9	-	-	-	18	3.2	3.2	-	-	-	3.8	6.3	7.3	1,104	1,840	2,931	
	7	12	-	-	-	19	2.5	4.2	-	-	-	4.0	6.7	7.4	1,206	2,010	3,039	
	9	12	-	-	-	21	3.2	4.2	-	-	-	4.4	7.4	8.1	1,356	2,260	3,225	
	12	12	-	-	-	24	4.2	4.2	-	-	-	5.1	8.4	9.3	1,608	2,680	3,412	
	7	18	-	-	-	25	2.5	6.3	-	-	-	5.3	8.8	10.1	1,656	2,760	3,578	
	9	18	-	-	-	27	3.2	6.3	-	-	-	5.7	9.5	10.9	1,728	2,880	3,627	
	12	18	-	-	-	30	4.0	6.1	-	-	-	6.1	10.1	11.1	1,728	2,880	3,627	
	7	24	-	-	-	31	2.3	7.8	-	-	-	6.1	10.1	11.1	1,728	2,880	3,627	
	9	24	-	-	-	33	2.8	7.4	-	-	-	6.1	10.1	11.1	1,728	2,880	3,627	
	18	18	-	-	-	36	5.1	5.1	-	-	-	6.1	10.1	11.6	1,728	2,880	3,627	
	12	24	-	-	-	36	3.4	6.7	-	-	-	6.1	10.1	11.1	1,728	2,880	3,627	
	18	24	-	-	-	42	4.3	5.8	-	-	-	6.1	10.1	11.1	1,728	2,880	3,627	
24	24	-	-	-	48	5.1	5.1	-	-	-	6.1	10.1	11.1	1,728	2,880	3,627		
3Unit	7	7	7	-	-	21	2.5	2.5	2.5	-	-	4.4	7.4	8.5	1,026	1,710	2,873	
	7	7	9	-	-	23	2.5	2.5	3.2	-	-	4.9	8.1	9.3	1,122	1,870	3,275	
	7	9	9	-	-	25	2.5	3.2	3.2	-	-	5.3	8.8	10.1	1,260	2,100	3,735	
	7	7	12	-	-	26	2.5	2.5	4.2	-	-	5.5	9.1	10.5	1,326	2,210	3,735	
	9	9	9	-	-	27	3.2	3.2	3.2	-	-	5.7	9.5	10.9	1,428	2,380	3,775	
	7	9	12	-	-	28	2.5	3.2	4.2	-	-	5.9	9.8	11.3	1,524	2,540	3,775	
	9	9	12	-	-	30	3.0	3.0	4.0	-	-	6.1	10.1	11.3	1,584	2,640	3,775	
	7	12	12	-	-	31	2.3	3.9	3.9	-	-	6.1	10.1	11.3	1,584	2,640	3,775	
	7	7	18	-	-	32	2.2	2.2	5.7	-	-	6.1	10.1	11.6	1,584	2,640	3,775	
	9	12	12	-	-	33	2.8	3.7	3.7	-	-	6.1	10.1	11.3	1,584	2,640	3,775	
	7	9	18	-	-	34	2.1	2.7	5.4	-	-	6.1	10.1	11.6	1,584	2,640	3,775	
	12	12	12	-	-	36	3.4	3.4	3.4	-	-	6.1	10.1	11.3	1,584	2,640	3,775	
	9	9	18	-	-	36	2.5	2.5	5.1	-	-	6.1	10.1	11.3	1,584	2,640	3,775	
	7	12	18	-	-	37	1.9	3.3	4.9	-	-	6.1	10.1	11.3	1,584	2,640	3,775	
	7	7	24	-	-	38	1.9	1.9	6.4	-	-	6.1	10.1	11.3	1,584	2,640	3,775	
	9	12	18	-	-	39	2.3	3.1	4.7	-	-	6.1	10.1	11.3	1,584	2,640	3,775	
	7	9	24	-	-	40	1.8	2.3	6.1	-	-	6.1	10.1	11.3	1,584	2,640	3,775	
	12	12	18	-	-	42	2.9	2.9	4.3	-	-	6.1	10.1	11.3	1,584	2,640	3,775	
	9	9	24	-	-	42	2.2	2.2	5.8	-	-	6.1	10.1	11.3	1,584	2,640	3,775	
	7	18	18	-	-	43	1.6	4.2	4.2	-	-	6.1	10.1	11.3	1,584	2,640	3,775	
	7	12	24	-	-	43	1.6	2.8	5.6	-	-	6.1	10.1	11.3	1,584	2,640	3,775	
	9	18	18	-	-	45	2.0	4.0	4.0	-	-	6.1	10.1	11.3	1,584	2,640	3,775	
	9	12	24	-	-	45	2.0	2.7	5.4	-	-	6.1	10.1	11.3	1,584	2,640	3,775	
	12	18	18	-	-	48	2.5	3.8	3.8	-	-	6.1	10.1	11.3	1,584	2,640	3,775	
	12	12	24	-	-	48	2.5	2.5	5.1	-	-	6.1	10.1	11.3	1,584	2,640	3,775	
	7	18	24	-	-	49	1.4	3.6	4.8	-	-	6.1	10.1	11.3	1,584	2,640	3,775	
	9	18	24	-	-	51	1.8	3.6	4.8	-	-	6.1	10.1	11.3	1,584	2,640	3,775	
	12	18	24	-	-	54	2.2	3.4	4.5	-	-	6.1	10.1	11.3	1,584	2,640	3,775	
18	18	18	-	-	54	3.4	3.4	3.4	-	-	6.1	10.1	11.3	1,584	2,640	3,775		

COMBINATION TABLE

UHXM90MA1

Operation	Combination (kW)						Heating											
							Each Capacity (kW)					Total Capacity (kW)			Total Input (W)			
	UNIT-A	UNIT-B	UNIT-C	UNIT-D	UNIT-E	Total	UNIT-A	UNIT-B	UNIT-C	UNIT-D	UNIT-E	kW	kW	kW	Min	Rated	Max	
4Unit	7	7	7	7	-	28	2.5	2.5	2.5	2.5	-	5.9	9.8	11.8	1,356	2,260	3,745	
	7	7	7	9	-	30	2.4	2.4	2.4	3.0	-	6.1	10.1	12.1	1,482	2,470	3,775	
	7	7	9	9	-	32	2.2	2.2	2.8	2.8	-	6.1	10.1	12.1	1,482	2,470	3,775	
	7	9	9	9	-	34	2.1	2.7	2.7	2.7	-	6.1	10.1	12.1	1,482	2,470	3,775	
	7	7	9	12	-	35	2.0	2.0	2.6	3.5	-	6.1	10.1	12.1	1,482	2,470	3,775	
	9	9	9	9	-	36	2.5	2.5	2.5	2.5	-	6.1	10.1	12.1	1,482	2,470	3,775	
	7	9	9	12	-	37	1.9	2.5	2.5	3.3	-	6.1	10.1	12.1	1,482	2,470	3,775	
	7	7	12	12	-	38	1.9	1.9	3.2	3.2	-	6.1	10.1	11.6	1,482	2,470	3,775	
	9	9	9	12	-	39	2.3	2.3	2.3	3.1	-	6.1	10.1	12.1	1,482	2,470	3,775	
	7	7	7	18	-	39	1.8	1.8	1.8	4.7	-	6.1	10.1	12.1	1,482	2,470	3,775	
	7	9	12	12	-	40	1.8	2.3	3.0	3.0	-	6.1	10.1	11.6	1,482	2,470	3,775	
	7	7	9	18	-	41	1.7	1.7	2.2	4.4	-	6.1	10.1	11.6	1,482	2,470	3,775	
	9	9	12	12	-	42	2.2	2.2	2.9	2.9	-	6.1	10.1	11.6	1,482	2,470	3,775	
	7	12	12	12	-	43	1.6	2.8	2.8	2.8	-	6.1	10.1	11.6	1,482	2,470	3,775	
	7	9	9	18	-	43	1.6	2.1	2.1	4.2	-	6.1	10.1	12.1	1,482	2,470	3,775	
	7	7	12	18	-	44	1.6	1.6	2.8	4.1	-	6.1	10.1	12.1	1,482	2,470	3,775	
	9	12	12	12	-	45	2.0	2.7	2.7	2.7	-	6.1	10.1	11.6	1,482	2,470	3,775	
	9	9	9	18	-	45	2.0	2.0	2.0	4.0	-	6.1	10.1	12.1	1,482	2,470	3,775	
	7	7	7	24	-	45	1.6	1.6	1.6	5.4	-	6.1	10.1	11.6	1,482	2,470	3,775	
	7	9	12	18	-	46	1.5	2.0	2.6	4.0	-	6.1	10.1	12.1	1,482	2,470	3,775	
	7	7	9	24	-	47	1.5	1.5	1.9	5.2	-	6.1	10.1	11.6	1,482	2,470	3,775	
	12	12	12	12	-	48	2.5	2.5	2.5	2.5	-	6.1	10.1	12.1	1,482	2,470	3,775	
	9	9	12	18	-	48	1.9	1.9	2.5	3.8	-	6.1	10.1	12.1	1,482	2,470	3,775	
	7	12	12	18	-	49	1.4	2.5	2.5	3.7	-	6.1	10.1	12.1	1,482	2,470	3,775	
	7	9	9	24	-	49	1.4	1.9	1.9	4.9	-	6.1	10.1	12.1	1,482	2,470	3,775	
	7	7	12	24	-	50	1.4	1.4	2.4	4.8	-	6.1	10.1	11.6	1,482	2,470	3,775	
	9	12	12	18	-	50	1.4	1.4	3.6	3.6	-	6.1	10.1	12.1	1,482	2,470	3,775	
	9	9	9	24	-	51	1.8	1.8	1.7	4.8	-	6.1	10.1	11.6	1,482	2,470	3,775	
	7	9	12	24	-	52	1.4	1.7	2.3	4.7	-	6.1	10.1	12.1	1,482	2,470	3,775	
	9	9	12	24	-	54	1.7	1.7	2.2	4.5	-	6.1	10.1	11.6	1,482	2,470	3,775	
	9	9	18	18	-	54	1.7	1.7	3.4	3.4	-	6.1	10.1	12.1	1,482	2,470	3,775	
	12	12	12	18	-	54	2.2	2.2	2.2	3.4	-	6.1	10.1	12.1	1,482	2,470	3,775	
	5Unit	7	7	7	7	7	35	2.0	2.0	2.0	2.0	2.0	6.1	10.1	12.1	1,320	2,200	3,700
		7	7	7	7	9	37	1.9	1.9	1.9	1.9	2.5	6.1	10.1	12.1	1,320	2,200	3,700
		7	7	7	7	12	40	1.8	1.8	1.8	1.8	3.0	6.1	10.1	12.1	1,320	2,200	3,700
		7	7	9	9	9	41	1.7	1.7	2.2	2.2	2.2	6.1	10.1	12.1	1,320	2,200	3,700
		7	7	7	9	12	42	1.7	1.7	1.7	2.2	2.9	6.1	10.1	12.1	1,320	2,200	3,700
		7	9	9	9	9	43	1.6	2.1	2.1	2.1	2.1	6.1	10.1	12.1	1,320	2,200	3,700
		7	7	9	9	12	44	1.6	1.6	2.1	2.1	2.8	6.1	10.1	12.1	1,320	2,200	3,700
		9	9	9	9	9	45	2.0	2.0	2.0	2.0	2.0	6.1	10.1	12.1	1,320	2,200	3,700
7		7	7	7	18	46	1.5	1.5	1.5	1.5	4.0	6.1	10.1	12.1	1,320	2,200	3,700	
7		9	9	9	12	46	1.5	2.0	2.0	2.0	2.6	6.1	10.1	12.1	1,320	2,200	3,700	
7		7	9	12	12	47	1.5	1.5	1.9	2.6	2.6	6.1	10.1	12.1	1,320	2,200	3,700	
9		9	9	9	12	48	1.9	1.9	1.9	1.9	2.5	6.1	10.1	12.1	1,320	2,200	3,700	
7		7	7	12	12	45	1.6	1.6	1.6	2.7	2.7	6.1	10.1	12.1	1,320	2,200	3,700	
7		7	7	9	18	48	1.5	1.5	1.5	1.9	3.8	6.1	10.1	12.1	1,320	2,200	3,700	
7		9	9	12	12	49	1.4	1.9	1.9	2.5	2.5	6.1	10.1	12.1	1,320	2,200	3,700	
7		7	12	12	12	50	1.4	1.4	2.4	2.4	2.4	6.1	10.1	12.1	1,320	2,200	3,700	
7		7	9	9	18	50	1.4	1.4	1.8	1.8	3.6	6.1	10.1	12.1	1,320	2,200	3,700	
9		9	9	12	12	51	1.8	1.8	1.8	2.4	2.4	6.1	10.1	12.1	1,320	2,200	3,700	
7		7	7	12	18	51	1.4	1.4	1.4	2.4	3.6	6.1	10.1	12.1	1,320	2,200	3,700	
7		9	12	12	12	52	1.4	1.7	2.3	2.3	2.3	6.1	10.1	12.1	1,320	2,200	3,700	
7		9	9	9	18	52	1.4	1.7	1.7	1.7	3.5	6.1	10.1	12.1	1,320	2,200	3,700	
7		7	7	7	24	52	1.4	1.4	1.4	1.4	4.7	6.1	10.1	12.1	1,320	2,200	3,700	
7		7	9	12	18	53	1.3	1.3	1.7	2.3	3.4	6.1	10.1	12.1	1,320	2,200	3,700	
9		9	9	9	24	54	1.3	1.3	1.3	1.7	4.5	6.1	10.1	12.1	1,320	2,200	3,700	
9		9	9	9	18	54	1.7	1.7	1.7	1.7	3.4	6.1	10.1	12.1	1,320	2,200	3,700	
9		9	12	12	12	54	1.7	1.7	2.2	2.2	2.2	6.1	10.1	12.1	1,320	2,200	3,700	

Note :

1. Cooling Capacity is based on : indoor temp.27°CDB, 19°CWB ; outdoor temp. 35°CDB
2. Heating Capacity is based on : indoor temp.20°CDB ; outdoor temp. 7°CDB, 6°CWB
3. The total ability of connected a indoor unit is up to 14kW
4. At least two indoor units should be connected.

UHXM110MA1

Operation	Combination (kW)						Cooling										
							Each Capacity (kW)					Total Capacity (kW)			Total Input (W)		
	UNIT-A	UNIT-B	UNIT-C	UNIT-D	UNIT-E	Total	UNIT-A	UNIT-B	UNIT-C	UNIT-D	UNIT-E	Min	Rated	Max	Min	Rated	Max
1Unit	7	-	-	-	-	7	2.1	-	-	-	-	1.2	2.1	2.5	780	1,120	1,703
	9	-	-	-	-	9	2.6	-	-	-	-	1.6	2.6	3.2	780	1,120	1,703
	12	-	-	-	-	12	3.5	-	-	-	-	2.1	3.5	4.2	780	1,120	1,703
	18	-	-	-	-	18	5.3	-	-	-	-	3.2	5.3	6.3	800	1,260	1,915
	24	-	-	-	-	24	7.0	-	-	-	-	4.2	7.0	8.4	1,042	1,680	2,554
2Unit	7	7	-	-	-	14	2.1	2.1	-	-	-	2.5	4.1	4.9	780	1,120	1,703
	7	9	-	-	-	16	2.1	2.6	-	-	-	2.8	4.7	5.6	780	1,120	1,703
	9	9	-	-	-	18	2.6	2.6	-	-	-	3.2	5.3	6.3	800	1,260	1,915
	7	12	-	-	-	19	2.1	3.5	-	-	-	3.3	5.6	6.7	825	1,330	2,022
	9	12	-	-	-	21	2.6	3.5	-	-	-	3.7	6.2	7.4	911	1,470	2,235
	12	12	-	-	-	24	3.5	3.5	-	-	-	4.2	7.0	8.4	1,042	1,680	2,554
	7	18	-	-	-	25	2.1	5.3	-	-	-	4.4	7.3	8.8	1,085	1,750	2,660
	9	18	-	-	-	27	2.6	5.3	-	-	-	4.7	7.9	9.5	1,172	1,890	2,873
	12	18	-	-	-	30	3.5	5.3	-	-	-	5.3	8.8	10.6	1,302	2,100	3,192
	7	24	-	-	-	31	2.1	7.0	-	-	-	5.5	9.1	10.9	1,345	2,170	3,299
	9	24	-	-	-	33	2.6	7.0	-	-	-	5.8	9.7	11.6	1,432	2,310	3,512
	18	18	-	-	-	36	5.3	5.3	-	-	-	6.3	10.6	12.7	1,562	2,520	3,831
	12	24	-	-	-	36	3.5	7.0	-	-	-	6.3	10.6	12.7	1,562	2,520	3,831
	18	24	-	-	-	42	5.0	6.7	-	-	-	7.0	11.7	13.5	1,693	2,730	4,150
	24	24	-	-	-	48	5.9	5.9	-	-	-	7.0	11.7	13.5	1,693	2,730	4,150
3Unit	7	7	7	-	-	21	2.1	2.1	2.1	-	-	3.7	6.2	7.4	911	1,470	2,235
	7	7	9	-	-	23	2.1	2.1	2.6	-	-	4.0	6.7	8.1	998	1,610	2,447
	7	9	9	-	-	25	2.1	2.6	2.6	-	-	4.4	7.3	8.8	1,085	1,750	2,660
	7	7	12	-	-	26	2.1	2.1	3.5	-	-	4.6	7.6	9.1	1,128	1,820	2,767
	9	9	9	-	-	27	2.6	2.6	2.6	-	-	4.7	7.9	9.5	1,172	1,890	2,873
	7	9	12	-	-	28	2.1	2.6	3.5	-	-	4.9	8.2	9.8	1,215	1,960	2,979
	9	9	12	-	-	30	2.6	2.6	3.5	-	-	5.3	8.8	10.6	1,302	2,100	3,192
	7	12	12	-	-	31	2.1	3.5	3.5	-	-	5.5	9.1	10.9	1,345	2,170	3,299
	7	7	18	-	-	32	2.1	2.1	5.3	-	-	5.6	9.4	11.3	1,389	2,240	3,405
	9	12	12	-	-	33	2.6	3.5	3.5	-	-	5.8	9.7	11.6	1,432	2,310	3,512
	7	9	18	-	-	34	2.1	2.6	5.3	-	-	6.0	10.0	12.0	1,476	2,380	3,618
	12	12	12	-	-	36	3.5	3.5	3.5	-	-	6.3	10.6	12.7	1,562	2,520	3,831
	9	9	18	-	-	36	2.6	2.6	5.3	-	-	6.3	10.6	12.7	1,562	2,520	3,831
	7	12	18	-	-	37	2.1	3.5	5.3	-	-	6.5	10.8	13.0	1,606	2,590	3,937
	7	7	24	-	-	38	2.1	2.1	7.0	-	-	6.7	11.1	13.4	1,649	2,660	4,044
	9	12	18	-	-	39	2.6	3.4	5.2	-	-	6.7	11.2	13.5	1,693	2,730	4,150
	7	9	24	-	-	40	2.0	2.5	6.7	-	-	6.7	11.2	13.5	1,693	2,730	4,150
	12	12	18	-	-	42	3.2	3.2	4.8	-	-	6.7	11.2	13.5	1,693	2,730	4,150
	9	9	24	-	-	42	2.4	2.4	6.4	-	-	6.7	11.2	13.5	1,693	2,730	4,150
	7	18	18	-	-	43	1.8	4.7	4.7	-	-	6.7	11.2	13.5	1,693	2,730	4,150
	7	12	24	-	-	43	1.8	3.1	6.2	-	-	6.7	11.2	13.5	1,693	2,730	4,150
	9	18	18	-	-	45	2.2	4.5	4.5	-	-	6.7	11.2	13.5	1,693	2,730	4,150
	9	12	24	-	-	45	2.2	3.0	6.0	-	-	6.7	11.2	13.5	1,693	2,730	4,150
	12	18	18	-	-	48	2.8	4.2	4.2	-	-	6.7	11.2	13.5	1,693	2,730	4,150
	12	12	24	-	-	48	2.8	2.8	5.6	-	-	6.7	11.2	13.5	1,693	2,730	4,150
	7	18	24	-	-	49	1.6	4.1	5.5	-	-	6.7	11.2	13.5	1,693	2,730	4,150
	9	18	24	-	-	51	2.0	4.0	5.3	-	-	6.7	11.2	13.5	1,693	2,730	4,150
	12	18	24	-	-	54	2.0	4.0	5.3	-	-	6.7	11.2	13.5	1,693	2,730	4,150
	18	18	18	-	-	54	2.0	4.0	5.3	-	-	6.7	11.2	13.5	1,693	2,730	4,150
	9	24	24	-	-	57	2.0	4.0	5.3	-	-	6.7	11.2	13.5	1,693	2,730	4,150
12	24	24	-	-	60	2.0	4.0	5.3	-	-	6.7	11.2	13.5	1,693	2,730	4,150	
18	18	24	-	-	60	2.0	4.0	5.3	-	-	6.7	11.2	13.5	1,693	2,730	4,150	
18	24	24	-	-	66	2.0	4.0	5.3	-	-	6.7	11.2	13.5	1,693	2,730	4,150	
24	24	24	-	-	72	2.0	4.0	5.3	-	-	6.7	11.2	13.5	1,693	2,730	4,150	
4Unit	7	7	7	7	-	28	2.1	2.1	2.1	2.1	-	4.9	8.2	9.8	1,215	1,960	2,979
	7	7	7	9	-	30	2.1	2.1	2.1	2.6	-	5.3	8.8	10.6	1,302	2,100	3,192
	7	7	9	9	-	32	2.1	2.1	2.6	2.6	-	5.6	9.4	11.3	1,389	2,240	3,405
	7	7	7	12	-	33	2.1	2.1	2.1	3.5	-	5.8	9.7	11.6	1,432	2,310	3,512
	7	9	9	9	-	34	2.1	2.6	2.6	2.6	-	6.0	10.0	12.0	1,476	2,380	3,618
	7	7	9	12	-	35	2.1	2.1	2.6	3.5	-	6.2	10.3	12.3	1,519	2,450	3,724
9	9	9	9	-	36	2.6	2.6	2.6	2.6	-	6.3	10.6	12.7	1,562	2,520	3,831	

COMBINATION TABLE

UHXM110MA1

Operation	Combination (kW)						Cooling										
							Each Capacity (kW)					Total Capacity (kW)			Total Input (W)		
	UNIT-A	UNIT-B	UNIT-C	UNIT-D	UNIT-E	Total	UNIT-A	UNIT-B	UNIT-C	UNIT-D	UNIT-E	Min	Rated	Max	Min	Rated	Max
4Unit	7	9	9	12	-	37	2.1	2.6	2.6	3.5	-	6.5	10.8	13.0	1,606	2,590	3,937
	7	7	12	12	-	38	2.1	2.1	3.5	3.5	-	6.7	11.1	13.4	1,649	2,660	4,044
	9	9	9	12	-	39	2.6	2.6	2.6	3.4	-	6.7	11.2	13.5	1,693	2,730	4,150
	7	7	7	18	-	39	2.0	2.0	2.0	5.2	-	6.7	11.2	13.5	1,693	2,730	4,150
	7	9	12	12	-	40	2.0	2.5	3.4	3.4	-	6.7	11.2	13.5	1,693	2,730	4,150
	7	7	9	18	-	41	1.9	1.9	2.5	4.9	-	6.7	11.2	13.5	1,693	2,730	4,150
	9	9	12	12	-	42	2.4	2.4	3.2	3.2	-	6.7	11.2	13.5	1,693	2,730	4,150
	7	12	12	12	-	43	1.8	3.1	3.1	3.1	-	6.7	11.2	13.5	1,693	2,730	4,150
	7	9	9	18	-	43	1.8	2.3	2.3	4.7	-	6.7	11.2	13.5	1,693	2,730	4,150
	7	7	12	18	-	44	1.8	1.8	3.1	4.6	-	6.7	11.2	13.5	1,693	2,730	4,150
	9	12	12	12	-	45	2.2	3.0	3.0	3.0	-	6.7	11.2	13.5	1,693	2,730	4,150
	9	9	9	18	-	45	2.2	2.2	2.2	4.5	-	6.7	11.2	13.5	1,693	2,730	4,150
	7	7	7	24	-	45	1.7	1.7	1.7	6.0	-	6.7	11.2	13.5	1,693	2,730	4,150
	7	9	12	18	-	46	1.7	2.2	2.9	4.4	-	6.7	11.2	13.5	1,693	2,730	4,150
	7	7	9	24	-	47	1.7	1.7	2.1	5.7	-	6.7	11.2	13.5	1,693	2,730	4,150
	12	12	12	12	-	48	2.8	2.8	2.8	2.8	-	6.7	11.2	13.5	1,693	2,730	4,150
	9	9	12	18	-	48	2.1	2.1	2.8	4.2	-	6.7	11.2	13.5	1,693	2,730	4,150
	7	12	12	18	-	49	1.6	2.7	2.7	4.1	-	6.7	11.2	13.5	1,693	2,730	4,150
	7	9	9	24	-	49	1.6	2.1	2.1	5.5	-	6.7	11.2	13.5	1,693	2,730	4,150
	7	7	12	24	-	50	1.6	1.6	2.7	5.4	-	6.7	11.2	13.5	1,693	2,730	4,150
	7	7	18	18	-	50	1.6	1.6	4.0	4.0	-	6.7	11.2	13.5	1,693	2,730	4,150
	9	12	12	18	-	51	2.0	2.6	2.6	4.0	-	6.7	11.2	13.5	1,693	2,730	4,150
	9	9	9	24	-	51	2.0	2.0	2.0	5.3	-	6.7	11.2	13.5	1,693	2,730	4,150
	7	9	12	24	-	52	1.5	1.9	2.6	5.2	-	6.7	11.2	13.5	1,693	2,730	4,150
	9	9	12	24	-	54	1.9	1.9	2.5	5.0	-	6.7	11.2	13.5	1,693	2,730	4,150
	9	9	18	18	-	54	1.9	1.9	3.7	3.7	-	6.7	11.2	13.5	1,693	2,730	4,150
	12	12	12	18	-	54	2.5	2.5	2.5	3.7	-	6.7	11.2	13.5	1,693	2,730	4,150
	7	12	12	24	-	55	1.4	2.4	2.4	4.9	-	6.7	11.2	13.5	1,693	2,730	4,150
	7	12	18	18	-	55	1.4	2.4	3.7	3.7	-	6.7	11.2	13.5	1,693	2,730	4,150
	7	7	18	24	-	56	1.4	1.4	3.6	4.8	-	6.7	11.2	13.5	1,693	2,730	4,150
	9	12	12	24	-	57	1.8	2.4	2.4	4.7	-	6.7	11.2	13.5	1,693	2,730	4,150
	9	12	18	18	-	57	1.8	2.4	3.5	3.5	-	6.7	11.2	13.5	1,693	2,730	4,150
	7	9	18	24	-	58	1.4	1.7	3.5	4.6	-	6.7	11.2	13.5	1,693	2,730	4,150
	9	9	18	24	-	60	1.7	1.7	3.4	4.5	-	6.7	11.2	13.5	1,693	2,730	4,150
	12	12	12	24	-	60	2.2	2.2	2.2	4.5	-	6.7	11.2	13.5	1,693	2,730	4,150
	12	12	18	18	-	60	2.2	2.2	3.4	3.4	-	6.7	11.2	13.5	1,693	2,730	4,150
	7	12	18	24	-	61	1.3	2.2	3.3	4.4	-	6.7	11.2	13.5	1,693	2,730	4,150
	7	18	18	18	-	61	1.3	3.3	3.3	3.3	-	6.7	11.2	13.5	1,693	2,730	4,150
	7	7	24	24	-	62	1.3	1.3	4.3	4.3	-	6.7	11.2	13.5	1,693	2,730	4,150
	9	12	18	24	-	63	1.6	2.1	3.2	4.3	-	6.7	11.2	13.5	1,693	2,730	4,150
	9	18	18	18	-	63	1.6	3.2	3.2	3.2	-	6.7	11.2	13.5	1,693	2,730	4,150
	7	9	24	24	-	64	1.2	1.6	4.2	4.2	-	6.7	11.2	13.5	1,693	2,730	4,150
	9	9	24	24	-	66	1.5	1.5	4.1	4.1	-	6.7	11.2	13.5	1,693	2,730	4,150
	12	12	18	24	-	66	2.0	2.0	3.1	4.1	-	6.7	11.2	13.5	1,693	2,730	4,150
	12	18	18	18	-	66	2.0	3.1	3.1	3.1	-	6.7	11.2	13.5	1,693	2,730	4,150
	7	12	24	24	-	67	1.2	2.0	4.0	4.0	-	6.7	11.2	13.5	1,693	2,730	4,150
	7	18	18	24	-	67	1.2	3.0	3.0	4.0	-	6.7	11.2	13.5	1,693	2,730	4,150
	9	12	24	24	-	69	1.5	1.9	3.9	3.9	-	6.7	11.2	13.5	1,693	2,730	4,150
9	18	18	24	-	69	1.5	2.9	2.9	3.9	-	6.7	11.2	13.5	1,693	2,730	4,150	
12	12	24	24	-	72	1.9	1.9	3.7	3.7	-	6.7	11.2	13.5	1,693	2,730	4,150	
12	18	18	24	-	72	1.9	2.8	2.8	3.7	-	6.7	11.2	13.5	1,693	2,730	4,150	
18	18	18	18	-	72	2.8	2.8	2.8	2.8	-	6.7	11.2	13.5	1,693	2,730	4,150	
5Unit	7	7	7	7	7	35	2.1	2.1	2.1	2.1	2.1	6.2	10.3	12.3	1,519	2,450	3,724
	7	7	7	7	9	37	2.1	2.1	2.1	2.1	2.6	6.5	10.8	13.0	1,606	2,590	3,937
	7	7	7	9	9	39	2.0	2.0	2.0	2.6	2.6	6.7	11.2	13.5	1,693	2,730	4,150
	7	7	7	7	12	40	2.0	2.0	2.0	2.0	3.4	6.7	11.2	13.5	1,693	2,730	4,150
	7	7	9	9	9	41	1.9	1.9	2.5	2.5	2.5	6.7	11.2	13.5	1,693	2,730	4,150
	7	7	7	9	12	42	1.9	1.9	1.9	2.4	3.2	6.7	11.2	13.5	1,693	2,730	4,150
	7	9	9	9	9	43	1.8	2.3	2.3	2.3	2.3	6.7	11.2	13.5	1,693	2,730	4,150
	7	7	9	9	12	44	1.8	1.8	2.3	2.3	3.1	6.7	11.2	13.5	1,693	2,730	4,150
9	9	9	9	9	45	2.2	2.2	2.2	2.2	2.2	6.7	11.2	13.5	1,693	2,730	4,150	

Note :

1. Cooling Capacity is based on : indoor temp.27°CDB, 19°CWB ; outdoor temp. 35°CDB
2. Heating Capacity is based on : indoor temp.20°CDB ; outdoor temp. 7°CDB, 6°CWB
3. The total ability of connected a indoor unit is up to 14kW
4. At least two indoor units should be connected.

Operation	Combination (kW)						Cooling										
							Each Capacity (kW)					Total Capacity (kW)			Total Input (W)		
	UNIT-A	UNIT-B	UNIT-C	UNIT-D	UNIT-E	Total	UNIT-A	UNIT-B	UNIT-C	UNIT-D	UNIT-E	Min	Rated	Max	Min	Rated	Max
5Unit	7	7	7	7	18	46	1.7	1.7	1.7	1.7	4.4	6.7	11.2	13.5	1,693	2,730	4,150
	7	9	9	9	12	46	1.7	2.2	2.2	2.2	2.9	6.7	11.2	13.5	1,693	2,730	4,150
	7	7	9	12	12	47	1.7	1.7	2.1	2.9	2.9	6.7	11.2	13.5	1,693	2,730	4,150
	9	9	9	9	12	48	2.1	2.1	2.1	2.1	2.8	6.7	11.2	13.5	1,693	2,730	4,150
	7	7	7	12	12	45	1.7	1.7	1.7	3.0	3.0	6.7	11.2	13.5	1,693	2,730	4,150
	7	7	7	9	18	48	1.6	1.6	1.6	2.1	4.2	6.7	11.2	13.5	1,693	2,730	4,150
	7	9	9	12	12	49	1.6	2.1	2.1	2.7	2.7	6.7	11.2	13.5	1,693	2,730	4,150
	7	7	12	12	12	50	1.6	1.6	2.7	2.7	2.7	6.7	11.2	13.5	1,693	2,730	4,150
	7	7	9	9	18	50	1.6	1.6	2.0	2.0	4.0	6.7	11.2	13.5	1,693	2,730	4,150
	9	9	9	12	12	51	2.0	2.0	2.0	2.6	2.6	6.7	11.2	13.5	1,693	2,730	4,150
	7	7	7	12	18	51	1.5	1.5	1.5	2.6	4.0	6.7	11.2	13.5	1,693	2,730	4,150
	7	9	12	12	12	52	1.5	1.9	2.6	2.6	2.6	6.7	11.2	13.5	1,693	2,730	4,150
	7	9	9	9	18	52	1.5	1.9	1.9	1.9	3.9	6.7	11.2	13.5	1,693	2,730	4,150
	7	7	7	7	24	52	1.5	1.5	1.5	1.5	5.2	6.7	11.2	13.5	1,693	2,730	4,150
	7	7	9	12	18	53	1.5	1.5	1.9	2.5	3.8	6.7	11.2	13.5	1,693	2,730	4,150
	7	7	7	9	24	54	1.5	1.5	1.5	1.9	5.0	6.7	11.2	13.5	1,693	2,730	4,150
	9	9	9	9	18	54	1.9	1.9	1.9	1.9	3.7	6.7	11.2	13.5	1,693	2,730	4,150
	9	9	12	12	12	54	1.9	1.9	2.4	2.5	2.5	6.7	11.2	13.5	1,693	2,730	4,150
	7	9	9	12	18	55	1.4	1.8	1.8	2.4	3.7	6.7	11.2	13.5	1,693	2,730	4,150
	7	12	12	12	12	55	1.4	2.4	2.4	2.4	2.4	6.7	11.2	13.5	1,693	2,730	4,150
	7	7	9	9	24	56	1.4	1.4	1.8	1.8	4.8	6.7	11.2	13.5	1,693	2,730	4,150
	7	7	12	12	18	56	1.4	1.4	2.4	2.4	3.6	6.7	11.2	13.5	1,693	2,730	4,150
	7	7	7	12	24	57	1.4	1.4	1.4	2.4	4.7	6.7	11.2	13.5	1,693	2,730	4,150
	7	7	7	18	18	57	1.4	1.4	1.4	3.5	3.6	6.7	11.2	13.5	1,693	2,730	4,150
	9	9	9	12	18	57	1.8	1.8	1.8	2.4	3.6	6.7	11.2	13.5	1,693	2,730	4,150
	9	12	12	12	12	57	1.8	2.4	2.4	2.4	2.4	6.7	11.2	13.5	1,693	2,730	4,150
	7	9	9	9	24	58	1.4	1.7	1.7	1.7	4.6	6.7	11.2	13.5	1,693	2,730	4,150
	7	9	12	12	18	58	1.4	1.7	2.3	2.3	3.5	6.7	11.2	13.5	1,693	2,730	4,150
	7	7	9	12	24	59	1.3	1.3	1.7	2.3	4.6	6.7	11.2	13.5	1,693	2,730	4,150
	7	7	9	18	18	59	1.3	1.3	1.7	3.4	3.4	6.7	11.2	13.5	1,693	2,730	4,150
	9	9	9	9	24	60	1.7	1.7	1.7	1.7	4.5	6.7	11.2	13.5	1,693	2,730	4,150
	9	9	12	12	18	60	1.7	1.7	2.2	2.2	3.4	6.7	11.2	13.5	1,693	2,730	4,150
	12	12	12	12	12	60	2.2	2.2	2.2	2.2	2.2	6.7	11.2	13.5	1,693	2,730	4,150
	7	9	9	12	24	61	1.3	1.7	1.7	2.2	4.4	6.7	11.2	13.5	1,693	2,730	4,150
	7	9	9	18	18	61	1.3	1.7	1.7	3.3	3.3	6.7	11.2	13.5	1,693	2,730	4,150
	7	12	12	12	18	61	1.3	2.2	2.2	2.2	3.3	6.7	11.2	13.5	1,693	2,730	4,150
	7	7	12	12	24	62	1.3	1.3	2.2	2.2	4.3	6.7	11.2	13.5	1,693	2,730	4,150
	7	7	12	18	18	62	1.3	1.3	2.2	3.3	3.3	6.7	11.2	13.5	1,693	2,730	4,150
	9	9	9	12	24	63	1.6	1.6	1.6	2.1	4.3	6.7	11.2	13.5	1,693	2,730	4,150
	9	9	9	18	18	63	1.6	1.6	1.6	3.2	3.2	6.7	11.2	13.5	1,693	2,730	4,150
	9	12	12	12	18	63	1.6	2.1	2.1	2.1	3.2	6.7	11.2	13.5	1,693	2,730	4,150
	7	9	12	12	24	64	1.2	1.6	2.1	2.1	4.2	6.7	11.2	13.5	1,693	2,730	4,150
	7	9	12	18	18	64	1.2	1.6	2.1	3.2	3.2	6.7	11.2	13.5	1,693	2,730	4,150
	7	7	9	18	24	65	1.2	1.2	1.6	3.1	4.1	6.7	11.2	13.5	1,693	2,730	4,150
	9	9	12	12	24	66	1.5	1.5	2.0	2.0	4.1	6.7	11.2	13.5	1,693	2,730	4,150
	9	9	12	18	18	66	1.5	1.5	2.0	3.1	3.1	6.7	11.2	13.5	1,693	2,730	4,150
	12	12	12	12	18	66	2.0	2.0	2.0	2.0	3.1	6.7	11.2	13.5	1,693	2,730	4,150
	7	9	9	18	24	67	1.2	1.5	1.5	3.0	1.0	6.7	11.2	13.5	1,693	2,730	4,150
	7	12	12	12	24	67	1.2	2.0	2.0	2.0	1.0	6.7	11.2	13.5	1,693	2,730	4,150
	7	12	12	18	18	67	1.2	2.0	2.0	3.0	3.0	6.7	11.2	13.5	1,693	2,730	4,150
7	7	12	18	24	68	1.2	1.2	2.0	3.0	4.0	6.7	11.2	13.5	1,693	2,730	4,150	
9	12	12	12	24	69	1.5	1.9	1.9	1.9	3.9	6.7	11.2	13.5	1,693	2,730	4,150	
9	12	12	18	18	69	1.5	1.9	1.9	2.9	2.9	6.7	11.2	13.5	1,693	2,730	4,150	
7	9	18	18	18	70	1.1	1.4	2.9	2.9	2.9	6.7	11.2	13.5	1,693	2,730	4,150	
7	7	9	24	24	71	1.1	1.1	1.4	3.8	3.8	6.7	11.2	13.5	1,693	2,730	4,150	
9	9	12	18	24	72	1.4	1.4	1.9	2.8	3.7	6.7	11.2	13.5	1,693	2,730	4,150	
9	9	18	18	18	72	1.4	1.4	2.8	2.8	2.8	6.7	11.2	13.5	1,693	2,730	4,150	
12	12	12	12	24	72	1.9	1.9	1.9	1.9	3.7	6.7	11.2	13.5	1,693	2,730	4,150	
12	12	12	18	18	72	1.9	1.9	1.9	2.8	2.8	6.7	11.2	13.5	1,693	2,730	4,150	

Note :

1. Cooling Capacity is based on : indoor temp.27°CDB, 19°CWB ; outdoor temp. 35°CDB / 2. Heating Capacity is based on : indoor temp.20°CDB ; outdoor temp. 7°CDB, 6°CWB
3. The total ability of connected a indoor unit is up to 14kW / 4. At least two indoor units should be connected.

COMBINATION TABLE

UHXM110MA1

Operation	Combination (kW)						Heating										
							Each Capacity (kW)					Total Capacity (kW)			Total Input (W)		
	UNIT-A	UNIT-B	UNIT-C	UNIT-D	UNIT-E	Total	UNIT-A	UNIT-B	UNIT-C	UNIT-D	UNIT-E	Min	Rated	Max	Min	Rated	Max
1Unit	7	-	-	-	-	7	2.3	-	-	-	-	1.4	2.3	2.7	820	1,120	1,826
	9	-	-	-	-	9	2.9	-	-	-	-	1.7	2.9	3.5	820	1,120	1,826
	12	-	-	-	-	12	3.9	-	-	-	-	2.3	3.9	4.6	820	1,120	1,826
	18	-	-	-	-	18	5.8	-	-	-	-	3.5	5.8	7.0	820	1,260	2,054
	24	-	-	-	-	24	7.7	-	-	-	-	4.6	7.7	9.3	1,042	1,680	2,738
2Unit	7	7	-	-	-	14	2.3	2.3	-	-	-	2.7	4.5	5.4	820	1,120	1,826
	7	9	-	-	-	16	2.3	2.9	-	-	-	3.1	5.2	6.2	820	1,120	1,826
	9	9	-	-	-	18	2.9	2.9	-	-	-	3.5	5.8	7.0	820	1,260	2,054
	7	12	-	-	-	19	2.3	3.9	-	-	-	3.7	6.1	7.4	825	1,330	2,168
	9	12	-	-	-	21	2.9	3.9	-	-	-	4.1	6.8	8.1	911	1,470	2,396
	12	12	-	-	-	24	3.9	3.9	-	-	-	4.6	7.7	9.3	1,042	1,680	2,738
	7	18	-	-	-	25	2.3	5.8	-	-	-	4.8	8.1	9.7	1,085	1,750	2,853
	9	18	-	-	-	27	2.9	5.8	-	-	-	5.2	8.7	10.4	1,172	1,890	3,081
	12	18	-	-	-	30	3.9	5.8	-	-	-	5.8	9.7	11.6	1,302	2,100	3,423
	7	24	-	-	-	31	2.3	7.7	-	-	-	6.0	10.0	12.0	1,345	2,170	3,537
	9	24	-	-	-	33	2.9	7.7	-	-	-	6.4	10.6	12.8	1,432	2,310	3,765
	18	18	-	-	-	36	5.8	5.8	-	-	-	7.0	11.6	13.9	1,562	2,520	4,108
	12	24	-	-	-	36	3.9	7.7	-	-	-	7.0	11.6	13.9	1,562	2,520	4,108
	18	24	-	-	-	42	5.4	7.2	-	-	-	7.5	12.5	15.0	1,742	2,810	4,450
	24	24	-	-	-	48	6.3	6.3	-	-	-	7.5	12.5	15.0	1,742	2,810	4,450
3Unit	7	7	7	-	-	21	2.3	2.3	2.3	-	-	4.1	6.8	8.1	911	1,470	2,396
	7	7	9	-	-	23	2.3	2.3	2.9	-	-	4.4	7.4	8.9	998	1,610	2,624
	7	9	9	-	-	25	2.3	2.9	2.9	-	-	4.8	8.1	9.7	1,085	1,750	2,853
	7	7	12	-	-	26	2.3	2.3	3.9	-	-	5.0	8.4	10.1	1,128	1,820	2,967
	9	9	9	-	-	27	2.9	2.9	2.9	-	-	5.2	8.7	10.4	1,172	1,890	3,081
	7	9	12	-	-	28	2.3	2.9	3.9	-	-	5.4	9.0	10.8	1,215	1,960	3,195
	9	9	12	-	-	30	2.9	2.9	3.9	-	-	5.8	9.7	11.6	1,302	2,100	3,423
	7	12	12	-	-	31	2.3	3.9	3.9	-	-	6.0	10.0	12.0	1,345	2,170	3,537
	7	7	18	-	-	32	2.3	2.3	5.8	-	-	6.2	10.3	12.4	1,389	2,240	3,651
	9	12	12	-	-	33	2.9	3.9	3.9	-	-	6.4	10.6	12.8	1,432	2,310	3,765
	7	9	18	-	-	34	2.3	2.9	5.8	-	-	6.6	11.0	13.2	1,476	2,380	3,879
	12	12	12	-	-	36	3.9	3.9	3.9	-	-	7.0	11.6	13.9	1,562	2,520	4,108
	9	9	18	-	-	36	2.9	2.9	5.8	-	-	7.0	11.6	13.9	1,562	2,520	4,108
	7	12	18	-	-	37	2.3	3.9	5.8	-	-	7.2	11.9	14.3	1,606	2,590	4,222
	7	7	24	-	-	38	2.3	2.3	7.7	-	-	7.4	12.3	14.7	1,649	2,660	4,336
	9	12	18	-	-	39	2.9	3.9	5.8	-	-	7.5	12.5	15.0	1,742	2,810	4,450
	7	9	24	-	-	40	2.2	2.8	7.5	-	-	7.5	12.5	15.0	1,742	2,810	4,450
	12	12	18	-	-	42	3.6	3.6	5.4	-	-	7.5	12.5	15.0	1,742	2,810	4,450
	9	9	24	-	-	42	2.7	2.7	7.2	-	-	7.5	12.5	15.0	1,742	2,810	4,450
	7	18	18	-	-	43	2.0	5.2	5.2	-	-	7.5	12.5	15.0	1,742	2,810	4,450
	7	12	24	-	-	43	2.0	3.5	7.0	-	-	7.5	12.5	15.0	1,742	2,810	4,450
	9	18	18	-	-	45	2.5	5.0	5.0	-	-	7.5	12.5	15.0	1,742	2,810	4,450
	9	12	24	-	-	45	2.5	3.3	6.7	-	-	7.5	12.5	15.0	1,742	2,810	4,450
	12	18	18	-	-	48	3.1	4.7	4.7	-	-	7.5	12.5	15.0	1,742	2,810	4,450
	12	12	24	-	-	48	3.1	3.1	6.3	-	-	7.5	12.5	15.0	1,742	2,810	4,450
	7	18	24	-	-	49	1.8	4.6	6.1	-	-	7.5	12.5	15.0	1,742	2,810	4,450
	9	18	24	-	-	51	2.2	4.4	5.9	-	-	7.5	12.5	15.0	1,742	2,810	4,450
	12	18	24	-	-	54	2.0	4.0	5.3	-	-	7.5	12.5	15.0	1,742	2,810	4,450
	18	18	18	-	-	54	2.0	4.0	5.3	-	-	7.5	12.5	15.0	1,742	2,810	4,450
	9	24	24	-	-	57	2.0	4.0	5.3	-	-	7.5	12.5	15.0	1,742	2,810	4,450
12	24	24	-	-	60	2.0	4.0	5.3	-	-	7.5	12.5	15.0	1,742	2,810	4,450	
18	18	24	-	-	60	2.0	4.0	5.3	-	-	7.5	12.5	15.0	1,742	2,810	4,450	
18	24	24	-	-	66	2.0	4.0	5.3	-	-	7.5	12.5	15.0	1,742	2,810	4,450	
24	24	24	-	-	72	2.0	4.0	5.3	-	-	7.5	12.5	15.0	1,742	2,810	4,450	
4Unit	7	7	7	7	-	28	2.3	2.3	2.3	2.3	-	5.4	9.0	10.8	1,215	1,960	3,195
	7	7	7	9	-	30	2.3	2.3	2.3	2.9	-	5.8	9.7	11.6	1,302	2,100	3,423
	7	7	9	9	-	32	2.3	2.3	2.9	2.9	-	6.2	10.3	12.4	1,389	2,240	3,651
	7	7	7	12	-	33	2.3	2.3	2.3	3.9	-	6.4	10.6	12.8	1,432	2,310	3,765
	7	9	9	9	-	34	2.3	2.9	2.9	2.9	-	6.6	11.0	13.2	1,476	2,380	3,879
7	7	9	12	-	35	2.3	2.3	2.9	3.9	-	6.8	11.3	13.5	1,519	2,450	3,994	
9	9	9	9	-	36	2.9	2.9	2.9	2.9	-	7.0	11.6	13.9	1,562	2,520	4,108	

UHXM110MA1

Operation	Combination (kW)						Heating										
							Each Capacity (kW)					Total Capacity (kW)			Total Input (W)		
	UNIT-A	UNIT-B	UNIT-C	UNIT-D	UNIT-E	Total	UNIT-A	UNIT-B	UNIT-C	UNIT-D	UNIT-E	Min	Rated	Max	Min	Rated	Max
4Unit	7	9	9	12	-	37	2.3	2.9	2.9	3.9	-	7.2	11.9	14.3	1,606	2,590	4,222
	7	7	12	12	-	38	2.3	2.3	3.9	3.9	-	7.4	12.3	14.7	1,649	2,660	4,336
	9	9	9	12	-	39	2.9	2.9	2.9	3.9	-	7.5	12.5	15.0	1,742	2,810	4,450
	7	7	7	18	-	39	2.2	2.2	2.2	5.8	-	7.5	12.5	15.0	1,742	2,810	4,450
	7	9	12	12	-	40	2.2	2.8	3.8	3.8	-	7.5	12.5	15.0	1,742	2,810	4,450
	7	7	9	18	-	41	2.1	2.1	2.7	5.5	-	7.5	12.5	15.0	1,742	2,810	4,450
	9	9	12	12	-	42	2.7	2.7	3.6	3.6	-	7.5	12.5	15.0	1,742	2,810	4,450
	7	12	12	12	-	43	2.0	3.5	3.5	3.5	-	7.5	12.5	15.0	1,742	2,810	4,450
	7	9	9	18	-	43	2.0	2.6	2.6	5.2	-	7.5	12.5	15.0	1,742	2,810	4,450
	7	7	12	18	-	44	2.0	2.0	3.4	5.1	-	7.5	12.5	15.0	1,742	2,810	4,450
	9	12	12	12	-	45	2.5	3.3	3.3	3.3	-	7.5	12.5	15.0	1,742	2,810	4,450
	9	9	9	18	-	45	2.5	2.5	2.5	5.0	-	7.5	12.5	15.0	1,742	2,810	4,450
	7	7	7	24	-	45	1.9	1.9	1.9	6.7	-	7.5	12.5	15.0	1,742	2,810	4,450
	7	9	12	18	-	46	1.9	2.4	3.3	4.9	-	7.5	12.5	15.0	1,742	2,810	4,450
	7	7	9	24	-	47	1.9	1.9	2.4	6.4	-	7.5	12.5	15.0	1,742	2,810	4,450
	12	12	12	12	-	48	3.1	3.1	3.1	3.1	-	7.5	12.5	15.0	1,742	2,810	4,450
	9	9	12	18	-	48	2.3	2.3	3.1	4.7	-	7.5	12.5	15.0	1,742	2,810	4,450
	7	12	12	18	-	49	1.8	3.1	3.1	4.6	-	7.5	12.5	15.0	1,742	2,810	4,450
	7	9	9	24	-	49	1.8	2.3	2.3	6.1	-	7.5	12.5	15.0	1,742	2,810	4,450
	7	7	12	24	-	50	1.8	1.8	3.0	6.0	-	7.5	12.5	15.0	1,742	2,810	4,450
	7	7	18	18	-	50	1.8	1.8	4.5	4.5	-	7.5	12.5	15.0	1,742	2,810	4,450
	9	12	12	18	-	51	2.2	2.9	2.9	4.4	-	7.5	12.5	15.0	1,742	2,810	4,450
	9	9	9	24	-	51	2.2	2.2	2.2	5.9	-	7.5	12.5	15.0	1,742	2,810	4,450
	7	9	12	24	-	52	1.7	2.2	2.9	5.8	-	7.5	12.5	15.0	1,742	2,810	4,450
	9	9	12	24	-	54	2.1	2.1	2.8	5.6	-	7.5	12.5	15.0	1,742	2,810	4,450
	9	9	18	18	-	54	2.1	2.1	4.2	4.2	-	7.5	12.5	15.0	1,742	2,810	4,450
	12	12	12	18	-	54	2.8	2.8	2.8	4.2	-	7.5	12.5	15.0	1,742	2,810	4,450
	7	12	12	24	-	55	1.6	2.7	2.7	5.5	-	7.5	12.5	15.0	1,742	2,810	4,450
	7	12	18	18	-	55	1.6	2.7	4.1	4.1	-	7.5	12.5	15.0	1,742	2,810	4,450
	7	7	18	24	-	56	1.6	1.6	4.0	5.4	-	7.5	12.5	15.0	1,742	2,810	4,450
	9	12	12	24	-	57	2.0	2.6	2.6	5.3	-	7.5	12.5	15.0	1,742	2,810	4,450
	9	12	18	18	-	57	2.0	2.6	3.9	3.9	-	7.5	12.5	15.0	1,742	2,810	4,450
	7	9	18	24	-	58	1.5	1.9	3.9	5.2	-	7.5	12.5	15.0	1,742	2,810	4,450
	9	9	18	24	-	60	1.9	1.9	3.8	5.0	-	7.5	12.5	15.0	1,742	2,810	4,450
	12	12	12	24	-	60	2.5	2.5	2.5	5.0	-	7.5	12.5	15.0	1,742	2,810	4,450
	12	12	18	18	-	60	2.5	2.5	3.8	3.8	-	7.5	12.5	15.0	1,742	2,810	4,450
	7	12	18	24	-	61	1.4	2.5	3.7	4.9	-	7.5	12.5	15.0	1,742	2,810	4,450
	7	18	18	18	-	61	1.4	3.7	3.7	3.7	-	7.5	12.5	15.0	1,742	2,810	4,450
	7	7	24	24	-	62	1.4	1.4	4.8	4.8	-	7.5	12.5	15.0	1,742	2,810	4,450
	9	12	18	24	-	63	1.8	2.4	3.6	4.8	-	7.5	12.5	15.0	1,742	2,810	4,450
9	18	18	18	-	63	1.8	3.6	3.6	3.6	-	7.5	12.5	15.0	1,742	2,810	4,450	
7	9	24	24	-	64	1.4	1.8	4.7	4.7	-	7.5	12.5	15.0	1,742	2,810	4,450	
9	9	24	24	-	66	1.7	1.7	4.5	4.5	-	7.5	12.5	15.0	1,742	2,810	4,450	
12	12	18	24	-	66	2.3	2.3	3.4	4.5	-	7.5	12.5	15.0	1,742	2,810	4,450	
12	18	18	18	-	66	2.3	3.4	3.4	3.4	-	7.5	12.5	15.0	1,742	2,810	4,450	
7	12	24	24	-	67	1.3	2.2	4.5	4.5	-	7.5	12.5	15.0	1,742	2,810	4,450	
7	18	18	24	-	67	1.3	3.4	3.4	4.5	-	7.5	12.5	15.0	1,742	2,810	4,450	
9	12	24	24	-	69	1.6	2.2	4.3	4.3	-	7.5	12.5	15.0	1,742	2,810	4,450	
9	18	18	24	-	69	1.6	3.3	3.3	4.3	-	7.5	12.5	15.0	1,742	2,810	4,450	
12	12	24	24	-	72	2.1	2.1	4.2	4.2	-	7.5	12.5	15.0	1,742	2,810	4,450	
12	18	18	24	-	72	2.1	3.1	3.1	4.2	-	7.5	12.5	15.0	1,742	2,810	4,450	
18	18	18	18	-	72	3.1	3.1	3.1	3.1	-	7.5	12.5	15.0	1,742	2,810	4,450	
5Unit	7	7	7	7	7	35	2.3	2.3	2.3	2.3	2.3	6.8	11.3	13.5	1,519	2,450	3,994
	7	7	7	7	9	37	2.3	2.3	2.3	2.3	2.9	7.2	11.9	14.3	1,606	2,590	4,222
	7	7	7	9	9	39	2.2	2.2	2.2	2.9	2.9	7.5	12.5	15.0	1,742	2,810	4,450
	7	7	7	7	12	40	2.2	2.2	2.2	2.2	3.8	7.5	12.5	15.0	1,742	2,810	4,450
	7	7	9	9	9	41	2.1	2.1	2.7	2.7	2.7	7.5	12.5	15.0	1,742	2,810	4,450
	7	7	7	9	12	42	2.1	2.1	2.1	2.7	3.6	7.5	12.5	15.0	1,742	2,810	4,450
	7	9	9	9	9	43	2.0	2.6	2.6	2.6	2.6	7.5	12.5	15.0	1,742	2,810	4,450
	7	7	9	9	12	44	2.0	2.0	2.6	2.6	3.4	7.5	12.5	15.0	1,742	2,810	4,450
9	9	9	9	9	45	2.5	2.5	2.5	2.5	2.5	7.5	12.5	15.0	1,742	2,810	4,450	

COMBINATION TABLE

UHXM110MA1

Operation	Combination (kW)						Heating										
							Each Capacity (kW)					Total Capacity (kW)			Total Input (W)		
	UNIT-A	UNIT-B	UNIT-C	UNIT-D	UNIT-E	Total	UNIT-A	UNIT-B	UNIT-C	UNIT-D	UNIT-E	Min	Rated	Max	Min	Rated	Max
5Unit	7	7	7	7	18	46	1.9	1.9	1.9	1.9	4.9	7.5	12.5	15.0	1,742	2,810	4,450
	7	9	9	9	12	46	1.9	2.4	2.4	2.4	3.3	7.5	12.5	15.0	1,742	2,810	4,450
	7	7	9	12	12	47	1.9	1.9	2.4	3.2	3.2	7.5	12.5	15.0	1,742	2,810	4,450
	9	9	9	9	12	48	2.3	2.3	2.3	2.3	3.1	7.5	12.5	15.0	1,742	2,810	4,450
	7	7	7	12	12	45	1.9	1.9	1.9	3.3	3.3	7.5	12.5	15.0	1,742	2,810	4,450
	7	7	7	9	18	48	1.8	1.8	1.8	2.3	4.7	7.5	12.5	15.0	1,742	2,810	4,450
	7	9	9	12	12	49	1.8	2.3	2.3	3.1	3.1	7.5	12.5	15.0	1,742	2,810	4,450
	7	7	12	12	12	50	1.8	1.8	3.0	3.0	3.0	7.5	12.5	15.0	1,742	2,810	4,450
	7	7	9	9	18	50	1.8	1.8	2.3	2.3	4.5	7.5	12.5	15.0	1,742	2,810	4,450
	9	9	9	12	12	51	2.2	2.2	2.2	2.9	2.9	7.5	12.5	15.0	1,742	2,810	4,450
	7	7	7	12	18	51	1.7	1.7	1.7	2.9	4.4	7.5	12.5	15.0	1,742	2,810	4,450
	7	9	12	12	12	52	1.7	2.2	2.9	2.9	2.9	7.5	12.5	15.0	1,742	2,810	4,450
	7	9	9	9	18	52	1.7	2.2	2.2	2.2	4.3	7.5	12.5	15.0	1,742	2,810	4,450
	7	7	7	7	24	52	1.7	1.7	1.7	1.7	5.8	7.5	12.5	15.0	1,742	2,810	4,450
	7	7	9	12	18	53	1.7	1.7	2.1	2.8	4.2	7.5	12.5	15.0	1,742	2,810	4,450
	7	7	7	9	24	54	1.6	1.6	1.6	2.1	5.6	7.5	12.5	15.0	1,742	2,810	4,450
	9	9	9	9	18	54	2.1	2.1	2.1	2.1	4.2	7.5	12.5	15.0	1,742	2,810	4,450
	9	9	12	12	12	54	2.1	2.1	2.8	2.8	2.8	7.5	12.5	15.0	1,742	2,810	4,450
	7	9	9	12	18	55	1.6	2.0	2.0	2.7	4.1	7.5	12.5	15.0	1,742	2,810	4,450
	7	12	12	12	12	55	1.6	2.7	2.7	2.7	2.8	7.5	12.5	15.0	1,742	2,810	4,450
	7	7	9	9	24	56	1.6	1.6	2.0	2.0	5.4	7.5	12.5	15.0	1,742	2,810	4,450
	7	7	12	12	18	56	1.6	1.6	2.4	2.8	4.0	7.5	12.5	15.0	1,742	2,810	4,450
	7	7	7	12	24	57	1.5	1.5	1.5	2.6	5.3	7.5	12.5	15.0	1,742	2,810	4,450
	7	7	7	18	18	57	1.5	1.5	1.5	3.9	3.9	7.5	12.5	15.0	1,742	2,810	4,450
	9	9	9	12	18	57	2.0	2.0	2.0	2.6	3.9	7.5	12.5	15.0	1,742	2,810	4,450
	9	12	12	12	12	57	2.0	2.6	2.6	2.6	2.6	7.5	12.5	15.0	1,742	2,810	4,450
	7	9	9	9	24	58	1.5	1.9	1.9	1.9	5.2	7.5	12.5	15.0	1,742	2,810	4,450
	7	9	12	12	18	58	1.5	1.9	2.6	2.6	3.9	7.5	12.5	15.0	1,742	2,810	4,450
	7	7	9	12	24	59	1.5	1.5	1.9	2.5	5.1	7.5	12.5	15.0	1,742	2,810	4,450
	7	7	9	18	18	59	1.5	1.5	1.9	3.8	3.8	7.5	12.5	15.0	1,742	2,810	4,450
	9	9	9	9	24	60	1.9	1.9	1.9	1.9	5.0	7.5	12.5	15.0	1,742	2,810	4,450
	9	9	12	12	18	60	1.9	1.9	2.5	2.5	3.8	7.5	12.5	15.0	1,742	2,810	4,450
	12	12	12	12	12	60	2.5	2.5	2.5	2.5	2.5	7.5	12.5	15.0	1,742	2,810	4,450
	7	9	9	12	24	61	1.4	1.8	1.8	2.5	4.9	7.5	12.5	15.0	1,742	2,810	4,450
	7	9	9	18	18	61	1.4	1.8	1.8	3.7	3.7	7.5	12.5	15.0	1,742	2,810	4,450
	7	12	12	12	18	61	1.4	2.4	2.5	2.5	3.7	7.5	12.5	15.0	1,742	2,810	4,450
	7	7	12	12	24	62	1.4	1.4	1.4	2.4	4.8	7.5	12.5	15.0	1,742	2,810	4,450
	7	7	12	18	18	62	1.4	1.4	1.4	3.6	3.6	7.5	12.5	15.0	1,742	2,810	4,450
	9	9	9	12	224	63	1.8	1.8	1.8	2.4	4.8	7.5	12.5	15.0	1,742	2,810	4,450
	9	9	9	18	18	63	1.8	1.8	1.8	3.6	3.6	7.5	12.5	15.0	1,742	2,810	4,450
	9	12	12	12	18	63	1.8	2.4	2.4	2.4	3.6	7.5	12.5	15.0	1,742	2,810	4,450
	7	9	12	12	24	64	1.4	1.8	2.3	2.3	4.7	7.5	12.5	15.0	1,742	2,810	4,450
7	9	12	18	18	64	1.4	1.8	2.3	3.5	3.5	7.5	12.5	15.0	1,742	2,810	4,450	
7	7	9	18	24	65	1.3	1.3	1.7	3.5	4.6	7.5	12.5	15.0	1,742	2,810	4,450	
9	9	12	12	24	66	1.7	1.7	2.3	2.3	4.5	7.5	12.5	15.0	1,742	2,810	4,450	
9	9	12	18	18	66	1.7	1.7	2.3	3.4	3.4	7.5	12.5	15.0	1,742	2,810	4,450	
12	12	12	12	18	66	2.3	2.3	2.3	2.3	3.4	7.5	12.5	15.0	1,742	2,810	4,450	
7	9	9	18	24	67	1.3	1.7	1.7	3.4	4.5	7.5	12.5	15.0	1,742	2,810	4,450	
7	12	12	12	24	67	1.3	2.2	2.2	2.2	4.5	7.5	12.5	15.0	1,742	2,810	4,450	
7	12	12	18	18	67	1.3	2.2	2.2	3.4	3.4	7.5	12.5	15.0	1,742	2,810	4,450	
7	7	12	18	24	68	1.3	1.3	2.2	3.3	4.4	7.5	12.5	15.0	1,742	2,810	4,450	
9	12	12	12	24	69	1.6	2.2	2.2	2.2	4.3	7.5	12.5	15.0	1,742	2,810	4,450	
9	12	12	18	18	69	1.6	2.2	2.2	3.3	3.3	7.5	12.5	15.0	1,742	2,810	4,450	
7	9	18	18	18	70	1.3	1.6	3.2	3.2	3.2	7.5	12.5	15.0	1,742	2,810	4,450	
7	7	9	24	24	71	1.2	1.2	1.6	4.2	4.2	7.5	12.5	15.0	1,742	2,810	4,450	
9	9	12	18	24	72	1.6	1.6	2.1	3.1	4.2	7.5	12.5	15.0	1,742	2,810	4,450	
9	9	18	18	18	72	1.6	1.6	3.1	3.1	3.1	7.5	12.5	15.0	1,742	2,810	4,450	
12	12	12	12	24	72	2.0	2.1	2.1	2.1	4.2	7.5	12.5	15.0	1,742	2,810	4,450	
12	12	12	18	18	72	2.0	2.1	2.1	3.1	3.1	7.5	12.5	15.0	1,742	2,810	4,450	

Note :

1. Cooling Capacity is based on : indoor temp.27°CDB, 19°CWB ; outdoor temp. 35°CDB
2. Heating Capacity is based on : indoor temp.20°CDB ; outdoor temp. 7°CDB, 6°CWB
3. The total ability of connected a indoor unit is up to 14kW
4. At least two indoor units should be connected.

UHXM160BA1

Total Indoor Unit Capacity (kW)	Cooling Capacity			Input (W)		
	Min (kW)	Rated (kW)	Max (kW)	Min (W)	Rated (W)	Max (W)
23	4.5	8.2	9.4	1,490	2,267	3,240
24	4.7	8.5	9.8	1,579	2,402	3,433
25	4.9	8.8	10.2	1,626	2,473	3,535
26	5.0	9.1	10.5	1,672	2,544	3,637
27	5.2	9.4	10.9	1,719	2,616	3,739
28	5.4	9.7	11.3	1,766	2,687	3,842
29	5.5	10.0	11.7	1,813	2,759	3,944
30	5.7	10.3	12.0	1,860	2,830	4,046
31	5.9	10.6	12.4	1,907	2,902	4,148
32	6.0	10.9	12.8	1,954	2,973	4,250
33	6.2	11.2	13.1	1,973	3,001	4,290
34	6.4	11.5	13.4	1,991	3,029	4,330
35	6.5	11.8	13.7	2,009	3,057	4,370
36	6.7	12.1	14.0	2,028	3,085	4,409
37	6.9	12.4	14.4	2,046	3,112	4,449
38	7.0	12.7	14.7	2,064	3,140	4,489
39	7.2	13.0	15.1	2,082	3,168	4,529
40	7.4	13.3	15.5	2,101	3,196	4,569
41	7.5	13.6	15.9	2,119	3,224	4,609
42	7.7	13.9	16.2	2,137	3,252	4,648
43	7.9	14.2	16.6	2,156	3,280	4,688
44	8.0	14.5	17.0	2,174	3,308	4,728
45	8.2	14.8	17.1	2,211	3,365	4,812
46	8.4	15.1	17.2	2,246	3,417	4,884
47	8.5	15.4	17.3	2,299	3,498	5,000
48	8.7	15.7	17.3	2,352	3,579	5,116
49	8.8	16.0	17.4	2,406	3,660	5,232
50	9.0	16.1	17.5	2,459	3,741	5,348
51	9.2	16.2	17.7	2,512	3,822	5,464
52	9.3	16.3	17.9	2,566	3,903	5,580
53	9.5	16.4	17.9	2,579	3,924	5,609
54	9.7	16.5	18.0	2,593	3,944	5,638
55	9.8	16.6	18.0	2,606	3,964	5,667
56	10.0	16.7	18.1	2,619	3,985	5,696
57	10.2	16.8	18.1	2,633	4,005	5,725
58	10.3	16.9	18.2	2,646	4,025	5,754
59	10.5	17.0	18.2	2,659	4,046	5,783
60	10.7	17.1	18.3	2,673	4,066	5,812
61	10.8	17.2	18.3	2,686	4,086	5,841
62	11.0	17.3	18.4	2,699	4,107	5,870
63	11.2	17.4	18.4	2,734	4,160	5,900
64	11.3	17.5	18.5	2,726	4,147	5,929
65	11.5	17.5	18.5	2,739	4,168	5,958
66	11.7	17.6	18.5	2,753	4,188	5,987
67	11.8	17.7	18.6	2,766	4,208	6,016
68	12.0	17.8	18.6	2,780	4,229	6,045
69	12.2	17.8	18.6	2,793	4,249	6,074
70	12.3	17.9	18.7	2,806	4,269	6,103
71	12.5	18.0	18.7	2,820	4,290	6,132
72	12.7	18.0	18.7	2,833	4,310	6,161
73	12.8	18.1	18.8	2,846	4,330	6,190
74	12.8	18.1	18.8	2,846	4,330	6,190
75	12.8	18.1	18.8	2,846	4,330	6,190
76	12.8	18.1	18.8	2,846	4,330	6,190
77	12.8	18.1	18.8	2,846	4,330	6,190
78	12.8	18.1	18.8	2,846	4,330	6,190
79	12.8	18.1	18.8	2,846	4,330	6,190
80	12.8	18.1	18.8	2,846	4,330	6,190
81	12.8	18.1	18.8	2,846	4,330	6,190
82	12.8	18.1	18.8	2,846	4,330	6,190
83	12.8	18.1	18.8	2,846	4,330	6,190
84	12.8	18.1	18.8	2,846	4,330	6,190
85	12.8	18.1	18.8	2,846	4,330	6,190
86	12.8	18.1	18.8	2,846	4,330	6,190
87	12.8	18.1	18.8	2,846	4,330	6,190
88	12.8	18.1	18.8	2,846	4,330	6,190
89	12.8	18.1	18.8	2,846	4,330	6,190
90	12.8	18.1	18.8	2,846	4,330	6,190
91	12.8	18.1	18.8	2,846	4,330	6,190
92	12.8	18.1	18.8	2,846	4,330	6,190
93	12.8	18.1	18.8	2,846	4,330	6,190
94	12.8	18.1	18.8	2,846	4,330	6,190
95	12.8	18.1	18.8	2,846	4,330	6,190
96	12.8	18.1	18.8	2,846	4,330	6,190
97	12.8	18.1	18.8	2,846	4,330	6,190
98	12.8	18.1	18.8	2,846	4,330	6,190
99	12.8	18.1	18.8	2,846	4,330	6,190
100	12.8	18.1	18.8	2,846	4,330	6,190

Note :

1.Cooling Capacity is based on : indoor temp.27°C DB, 19°C WB; outdoor temp. 35°C DB / 2.Heating Capacity is based on : indoor temp.20°C DB; outdoor temp. 7°C DB, 6°C WB / 3.The rated capacities above show the rise in the total indoor unit capacity when operating frequency is constant. Values for changes in capacity are fixed after accounting for variations in operating frequency and should be used as reference values. / 4.Total capacity index of indoor unit should be within 5.5-18.1kW(40%-130%) / 5.At least two indoor units should be connected.



For more information visit
lg.com/au